

**Model**  
**S4**  
**UHF**  
**Reader**  
  
**1 to 4**  
**Antenna**  
**Ports**



<b>Physical:</b>	Dimensions (Housing Only):	7.10" x 6.2" x 2.7"	180mm x 157mm x 69mm
	Weight (w/o mounting brackets)	2 lb. + 12 oz.	1243 grams
	Antenna Connectors:	TNC-Female	
	Number of Antenna Ports	1 to 4	
	Enclosure:	Aluminum	
<b>Read Range:</b>	Up to 25 meters, Tag and Antenna dependent		
<b>Certifications:</b>	FCC, ETSI, CE, RoHS, UL294		
	EPC Gen-2 ISO 18000-6 Standard		
<b>RF:</b>	FHSS (Frequency Hopping Spread Spectrum)		
	(30 dBm) 1W TPO (Total Power Output) at Antenna connector		
	dBm can be lowered through software command to accommodate higher gain Antennas		
<b>Extras:</b>	Relay 60VADC @ 350mA (NO) and Loop Detector (Input)		
	Adjustable Internal Beeper Rate		
<b>Electrical:</b>	Voltage Input:	8VDC to 28VDC	
	Draw:	1.2A Single Antenna	1.5A Four Antennas
	Frequency:	902-928 MHz	865.5-867.5 MHz
<b>Communications:</b>	Standard on all models:	USB and serial	(default 115.2k, 8, 1, N)
	Allen Bradley:	Ethernet/IP	DeviceNet
	Siemens:	Profibus	Profinet
	Modicon:	Modbus RTU	Modbus TCP
	Other:	TCPIP Ethernet	CAN Open (TBR)

**THIS READER REQUIRES EXTERNAL ANTENNAS, PAGES 10 thru 18**



**UHF Readers Made in the U.S.A.**





## Model UHF-3020 OEM MicroReader

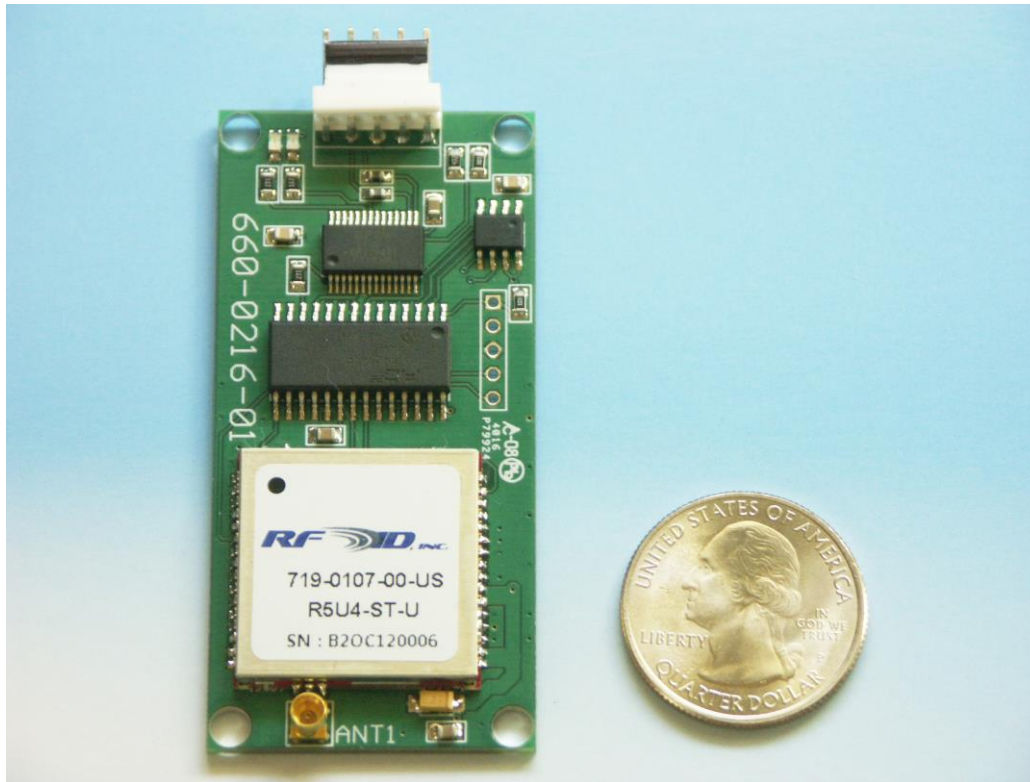

<b>Physical:</b>	Dimensions:	2.93754" x 1.75"	74mm x 32mm
	Antenna Connector:	MMCX	
	Weight:	0.5 oz.	13 grams
<b>Read Range:</b>	Up to 9 meters, Tag and Antenna dependent		
<b>Certifications:</b>	FCC, ETSI, CE, RoHS, UL294		
	EPC Gen-2 ISO 18000-6 Standard		
<b>RF:</b>	FHSS (Frequency Hopping Spread Spectrum)		
	(30 dBm) 1W TPO (Total Power Output) at Antenna connector		
	dBm can be lowered through software command to accommodate higher gain Antennas		
<b>Electrical:</b>	Voltage Input:	3.6VDC Nominal	
	Draw:	1.5A typical	
	Frequency:	866 MHz to 928 MHz	
<b>Environmental:</b>	Temperature, Storage:	-67°F to +185°F	-55°C to +85°C
	Temperature, Operating:	-40°F to +131°F	-40°C to +55°C
<b>Communications:</b>	USB	CMOS 3.3vdc	TTL 5vdc upon request

**THIS READER REQUIRES AN EXTERNAL ANTENNA, PAGES 10 thru 18**

**UHF Readers Made in the U.S.A.**



## Reader Part Numbers

Model Number	Part Number	Description
	For -0x suffix use: -01, -02, -03, or -04 to indicate number of Antenna ports	All Readers come with: Power connector for adaptation to AC power supply 9pin D-sub serial RS232 cable See accessories section below for AC power supply and audible beeper part numbers
S4-8030E-0x	808-8030-0x	Serial + USB Reader, 24VDC, 1 to 4 Antenna ports
S4-8040E-0x	808-8040-0x	Ethernet/IP + USB Reader + Serial, 24VDC, 1 to 4 Antenna ports
S4-8050E-0x	808-8050-0x	TCPIP Ethernet + USB Reader + Serial, 24VDC, 1 to 4 Antenna ports
S4-8060E-0x	808-8060-0x	DeviceNet + USB Reader + Serial, 24VDC, 1 to 4 Antenna ports
S4-8070E-0x	808-8070-0x	Profibus + USB Reader + Serial, 24VDC, 1 to 4 Antenna ports
S4-8075E-0x	808-8070-0x	PROFINET + USB Reader + Serial, 24VDC, 1 to 4 Antenna ports
S4-8080E-0x	808-8080-0x	Modbus TCP + USB Reader + Serial, 24VDC, 1 to 4 Antenna ports
S4-8085E-0x	808-8085-0x	Modbus RTU + USB Reader + Serial, 24VDC, 1 to 4 Antenna ports
UHF-3020-TTL	710-0216-00	MicroReader, UHF, TTL, 3.6v
UHF-3020-USB	710-0216-00-USB	MicroReader, UHF, USB, 3.6v

## Antenna Part Numbers

Model Number	Part Number	Description
UHF-A3205C	719-0032-.5C	32mm diameter x 5mm tall, ABS Antenna, 0.5dBi, SMA connector
UHF-A32M05C-Hex	719-0032-.5C-Hex	32mm diameter x 5mm tall, ABS Antenna, 0.5dBi, SMA connector, hex nut mount
UHF-A4030C	719-4030-.5C	40x30x13mm, ABS Antenna, 0.5dBi, mounting ears, SMA connector
UHF-A06C	719-0006-2C	6" Dual Whip Antennas, 2dBi, SMA connector
UHF-A115226C	719-115226-C	115x22x6mm with 40cm cable, sticky back, 2.5dBi, SMA connector
UHF-A115226C-MCX	719-115226-C-MCX	115x22x6mm with 40cm cable, sticky back, 2.5dBi, MCX connector
UHF-A25C	719-2525-02C	25x25x4mm Ceramic Antenna on 35mm backplane, 2dBi, mounting holes, SMA connector
UHF-A36C	719-3636-02C	36x36x4mm Ceramic Antenna on 40mm backplane, 2dBi, mounting holes, SMA connector
UHF-A45C	719-4545-03C	45x45x6mm Ceramic Antenna on 65mm backplane, 3dBi, mounting holes, SMA connector
UHF-A64C	719-6464-04C	64x64x6mm Ceramic Antenna on 65mm backplane, 4dBi, mounting holes, SMA connector
UHF-A80C	719-8080-55C	80x80x6mm Ceramic Antenna on 120mm backplane, 5.5dBi, mounting holes, SMA conn.
UHF-A80C-08	719-8080-08C	80x80x6mm Ceramic Antenna on 120mm backplane, 8dBi, mounting holes, SMA conn.
UHF-A55V	719-0505-02V	4.5" x 4.75" x 0.08", 2dBi, PCB, Vertical Polarized, 4 mounting holes, N Conn., 5' cable
UHF-A55C	719-0505-55C	5" x 5" x 0.75", 5.5dBi, Circular Polarized, ASA plastic, SMA Connector
UHF-A78R	719-0708-07C	7" x 8" x 1.75", 7dBi, Circular Polarized, mounting bracket, N Connector
UHF-A78V	719-0708-07V	7" x 8" x 1.75", 7dBi, Linear Vertical Polarized, mounting bracket, N Connector
UHF-A78H	719-0708-07H	7" x 8" x 1.75", 7dBi, Linear Horizontal Polarized, mounting bracket, N Connector
UHF-A99C	719-0909-09C	9.75" x 8.5" x 2.5", 9dBi, Circular Polarized, mounting bracket, N Connector
UHF-A99V	719-0909-09V	9.75" x 8.5" x 2.5", 9dBi, Linear Vertical Polarized, mounting bracket, N Connector
UHF-A99H	719-0909-09H	9.75" x 8.5" x 2.5", 9dBi, Linear Horizontal Polarized, mounting bracket, N Connector
UHF-A18C	719-1818-12C	18" sq. Ant x 1.25", 12dBi, Circular Polarized, mounting bracket, N Connector
UHF-A18V	719-1818-12V	18" sq. Ant x 1.25", 12dBi, Linear Vertical Polarized, mounting bracket, N Connector
UHF-A18H	719-1818-12H	18" sq. Ant x 1.25", 12dBi, Linear Horizontal Polarized, mounting bracket, N Connector
UHF-A3304	719-3304-12H	33" x 4" x 1", 12dBi, Linear Polarized, SMA connector



## Model SPR/A18 Single Piece Reader/Antenna – 12.5dBi

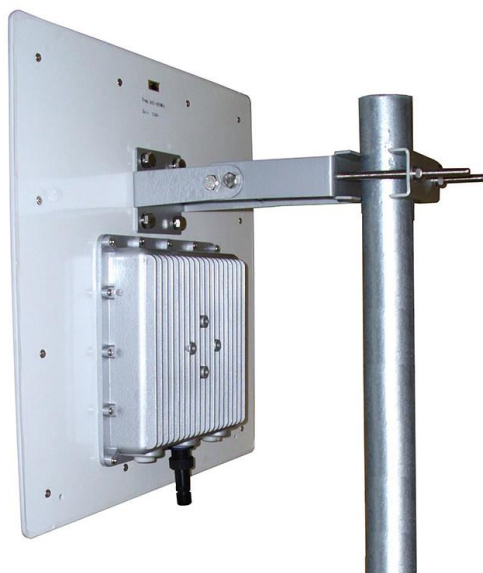

<b>Physical &amp; Electrical:</b>	Dimensions (Housing Only)	17.7" x 17.7" x 3.54"	450mm x 450mm x 90mm
	Weight (w/o mounting brackets)	4.4 lb.	2 kg
	Antenna Front Body	Radome, ABS w/UV Protection	Aluminum Back Plate
	Reader Rear Body	Aluminum	Bottom Cable Gland
	Voltage & Draw	8VDC to 28VDC	1.2 Amps
<b>Read Range:</b>	Up to 30 meters, Tag dependent		
<b>Certifications:</b>	FCC, ETSI, CE, RoHS, UL294 EPC Gen-2 ISO 18000-6 Standard		
<b>Antenna RF:</b>	C denotes Circular Polarized    H denotes Horizontal Polarized    V denotes Vertical Polarized Gain = 12dBi                          Horizontal Beam Width 45°                  Vertical Beam Width 45° 902-928 MHz North America    865.6-867.6 MHz Europe & others		
<b>Reader RF:</b>	FHSS (Frequency Hopping Spread Spectrum) Up to 4W (30 DBM) TPO (Total Power Output) Reader DBM can be lowered through software command to adjust range		
<b>Extras:</b>	Relay 60VADC @ 350mA (NO) and Loop Detector (Input) Adjustable Internal Beeper		
<b>Environmental:</b>	Temperature, Storage:	-67° to +185°F	-55° to +85°C
	Temperature, Operating:	-40° to +131°F	-40° to +55°C
	Ingress Protection:	IP65 or IP67 with added sealant	
<b>Comms:</b>	Standard on all models:	USB and Serial	(default 115.2k, 8, 1, N)
	Allen Bradley:	Ethernet/IP	DeviceNet
	Siemens:	Profibus	Profinet
	Modicon:	Modbus RTU	Modbus TCP
	Other:	TCPIP Ethernet	CAN Open (TBR)

UHF Readers Made in the U.S.A.



## Single Piece Reader/Antenna Part Numbers

Model Number	Part Number	Description
Choose C, V or H	Choose C, V, or H	
SPR/A18-8030E-12C/V/H	818-8030-18-12C/V/H	Single Piece Reader/Antenna combo, 18" sq., Serial/USB, 12dBi
SPR/A18-8040E-12C/V/H	818-8040-18-12C/V/H	Single Piece Reader/Antenna combo, 18" sq., Ethernet/IP/USB/Serial, 12dBi
SPR/A18-8050E-12C/V/H	818-8050-18-12C/V/H	Single Piece Reader/Antenna combo, 18" sq., TCPIP/USB/Serial, 12dBi
SPR/A18-8060E-12C/V/H	818-8060-18-12C/V/H	Single Piece Reader/Antenna combo, 18" sq., DeviceNet/USB/Serial, 12dBi
SPR/A18-8070E-12C/V/H	818-8070-18-12C/V/H	Single Piece Reader/Antenna combo, 18" sq., Profibus/USB/Serial, 12dBi
SPR/A18-8075E-12C/V/H	818-8075-18-12C/V/H	Single Piece Reader/Antenna combo, 18" sq., Profinet/USB/Serial, 12dBi
SPR/A18-8080E-12C/V/H	818-8080-18-12C/V/H	Single Piece Reader/Antenna combo, 18" sq., Modbus TCP/USB/Serial, 12dBi
SPR/A18-8085E-12C/V/H	818-8085-18-12C/V/H	Single Piece Reader/Antenna combo, 18" sq., Modbus RTU/USB/Serial, 12dBi

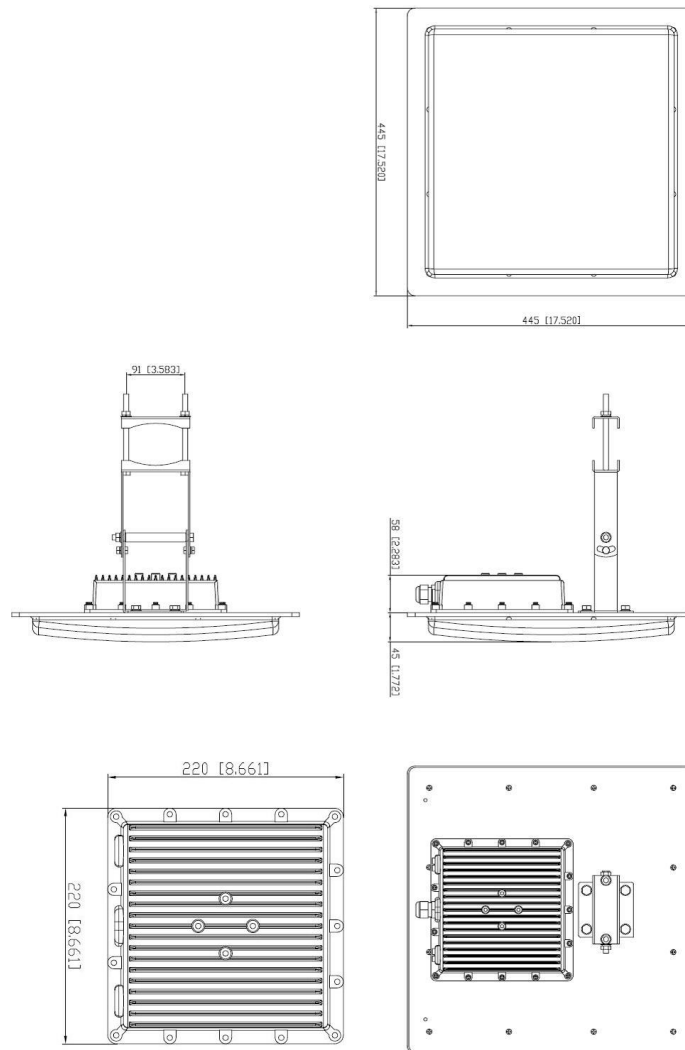

UHF Readers Made in the U.S.A.



## Model SPR/A10 Single Piece Reader/Antenna – 9dBi



<b>Physical &amp; Electrical:</b>	Dimensions (Housing Only)	10.15" x 10.15" x 3.82"	258mm x 258mm x 97mm
	Weight (w/o mounting brackets)	4 lb.	1.8 kg
	Antenna Front Body	Radome, ABS w/UV Protection	Aluminum Back Plate
	Reader Rear Body	Aluminum	Bottom Cable Gland
	Voltage & Draw	8VDC to 28VDC	1.2 Amps
<b>Read Range:</b>	Up to 25 meters, Tag dependent		
<b>Certifications:</b>	FCC, ETSI, CE, RoHS, UL294		
	EPC Gen-2 ISO 18000-6 Standard		
<b>Antenna RF:</b>	C denotes Circular Polarized    H denotes Horizontal Polarized    V denotes Vertical Polarized		
	Gain = 9dBi	Horizontal Beam Width 60°	Vertical Beam Width 65°
<b>Reader RF:</b>	902-928 MHz North America    865.6-867.6 MHz Europe & others		
	FHSS (Frequency Hopping Spread Spectrum)		
	Up to 4W (30 DBM) TPO (Total Power Output)		
	Reader DBM can be lowered through software command to adjust range		
<b>Extras:</b>	Relay (pins internal) 60VADC @ 350mA (NO) and Loop Detector (Input)		
	Adjustable Internal Beeper		
<b>Environmental:</b>	Temperature, Storage:	-67° to +185°F	-55° to +85°C
	Temperature, Operating:	-40° to +131°F	-40° to +55°C
	Ingress Protection:	IP65 or IP67 with added sealant	
<b>Comms:</b>	Standard on all models:	USB and Serial	(default 115.2k, 8, 1, N)
	Allen Bradley:	Ethernet/IP	DeviceNet
	Siemens:	Profibus	Profinet
	Modicon:	Modbus RTU	Modbus TCP
	Other:	TCPIP Ethernet	CAN Open (TBR)

UHF Readers Made in the U.S.A.

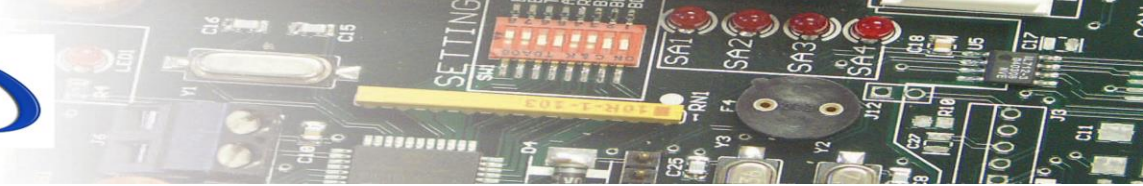

## Single Piece Reader/Antenna Part Numbers

Model Number	Part Number	Description
Choose C, V or H	Choose C, V, or H	
SPR/A10-8030E-9C/V/H	818-8030-10-9C/V/H	Single Piece Reader/Antenna combo, 10" sq., Serial/USB, 9dBi
SPR/A10-8040E-9C/V/H	818-8040-10-9C/V/H	Single Piece Reader/Antenna combo, 10" sq., Ethernet/IP/USB/Serial, 9dBi
SPR/A10-8050E-9C/V/H	818-8050-10-9C/V/H	Single Piece Reader/Antenna combo, 10" sq., TCP/IP/USB/Serial, 9dBi
SPR/A10-8060E-9C/V/H	818-8060-10-9C/V/H	Single Piece Reader/Antenna combo, 10" sq., DeviceNet/USB/Serial, 9dBi
SPR/A10-8070E-9C/V/H	818-8070-10-9C/V/H	Single Piece Reader/Antenna combo, 10" sq., Profibus/USB/Serial, 9dBi
SPR/A10-8075E-9C/V/H	818-8075-10-9C/V/H	Single Piece Reader/Antenna combo, 10" sq., Profinet/USB/Serial, 9dBi
SPR/A10-8080E-9C/V/H	818-8080-10-9C/V/H	Single Piece Reader/Antenna combo, 10" sq., Modbus TCP/USB/Serial, 9dBi
SPR/A10-8085E-9C/V/H	818-8085-10-9C/V/H	Single Piece Reader/Antenna combo, 10" sq., Modbus RTU/USB/Serial, 9dBi

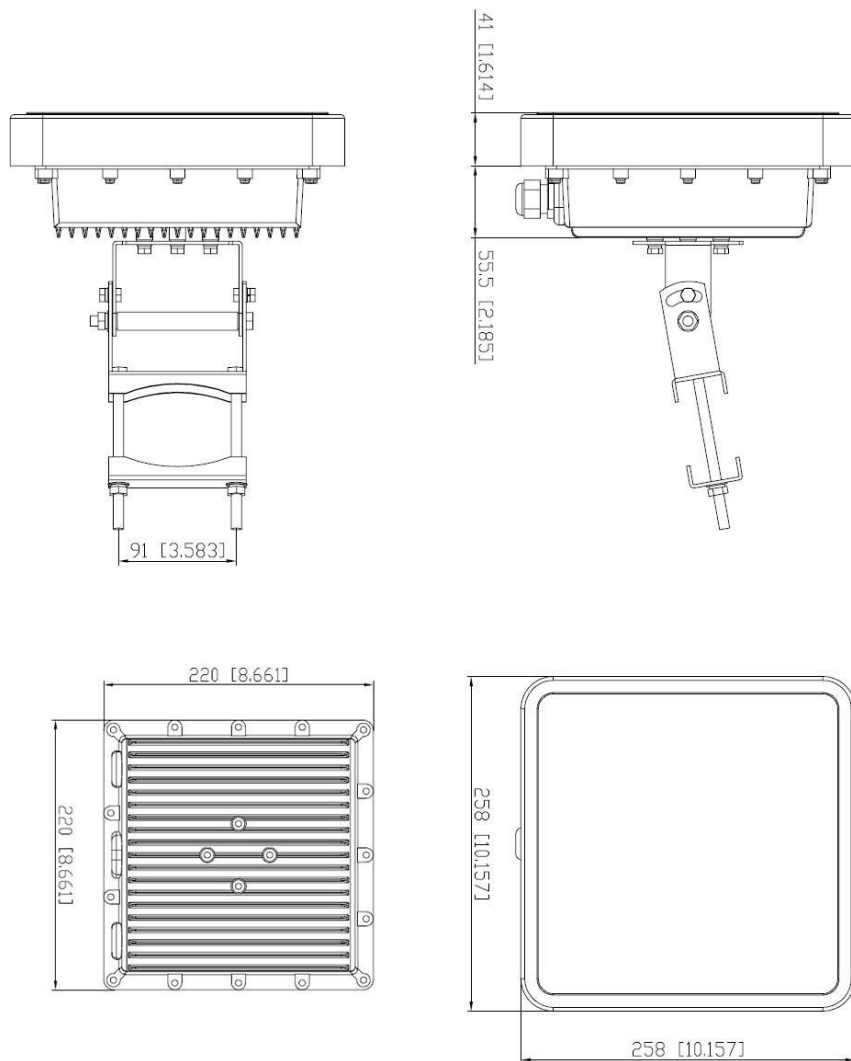

UHF Readers Made in the U.S.A.



## Model 3048E Hand Held UHF Reader/Writer - 865.5 to 928 MHz



<b>Physical &amp; Electrical:</b>	Dimensions	6.44 x 3.37 x 5.77	163.5mm x 85.7mm x 146.5mm
	Weight	18.3 ounces	520 grams
	Battery Duration	10 hours	
	Battery	Rechargeable Lithium Ion	3.7V 2500 mA
<b>Tag Range:</b>	Read: Up to 5 meters (16.5 feet) Write: Up to 1.5 meters (4.9 feet)		
<b>Certifications:</b>	FCC, ETSI, CE, RoHS, UL294, REACH, WEEE, ErP, NCC, SRRC, JRL, RCM(AU) EPC Gen-2 UHF Global ISO 18000-6 Standard		
<b>Internal:</b>	CPU – ARM Cortex-M3 32 bit		
	Memory – 4MB		
<b>Reader RF:</b>	902-928 MHz North America 865.5-867.5 MHz Europe & others		
	FHSS (Frequency Hopping Spread Spectrum)		
	Up to 4W (30 DBM) TPO (Total Power Output)		
<b>Extras:</b>	2 function keys, 1 trigger key, 1 toggle switch		
	Internal beeper, vibrator, tri-color LED's		
<b>Accessories:</b>	Battery charger, 2 batteries, micro USB cable, all standard		
<b>Environmental:</b>	Temperature, Storage	-22° to 158°F	-30° to 70°C
	Temperature, Operating	14° to 122°F	-40° to 55°C
	Ingress Protection	IP64	
	Humidity	Storage 5% to 95%	Operating 10% to 90%
	Drop Tests	1.5m onto concrete (100x)	1m tumble onto concrete (1000x)
<b>Comms:</b>	USB	Virtual COM	
	Bluetooth	SPP Slave	Master, HID
	WPAN	Bluetooth V4.0 dual mode	2.1 + EDR/BLE





## Model 3048E Hand Held UHF Reader/Writer - 865.5 to 928 MHz

Model Number	Part Number	Description
3048E	806-0068-00	Model 3048E Hand Held Mobile Reader/Writer (2 batteries & charger included)
3048E-AND	806-0068-00-AND	Android
3048E-MNT	806-0068-00-MNT	Android Mounting Hardware
3048E-BAT	806-0068-00-BAT	Battery (2 each standard with Reader)
3048E-CHG	806-0068-00-CHG	Charger (1 each standard with Reader)

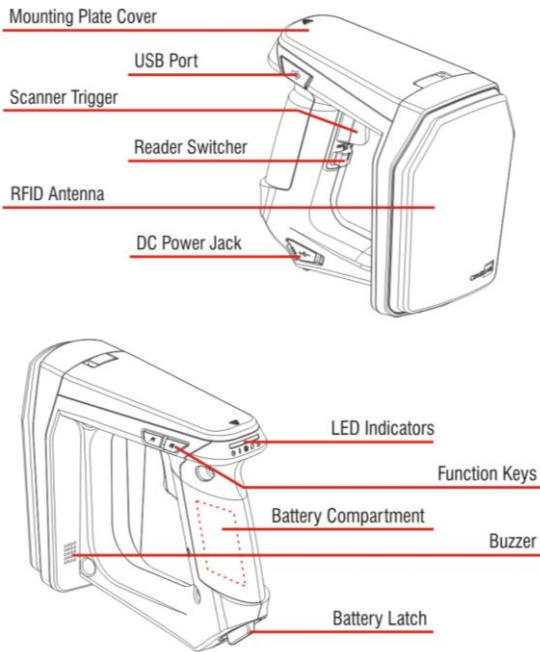



**Antennas**

**Model UHF-A18C**

**Model UHF-A18H**

**Model UHF-A18V**

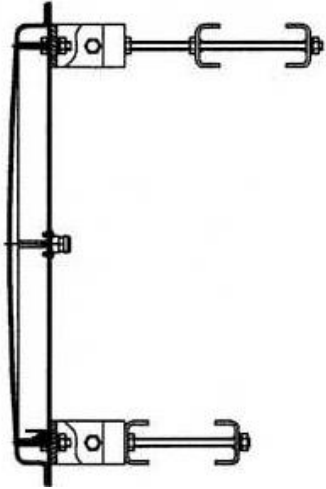

<b>Physical:</b>	Dimensions (Housing Only):	18" x 18" x 1.4"	450mm x 450mm x 35mm
	Weight (w/mounting hardware):	10 lbs.	4.5 KG
	Connector:	N Type (Female)	

<b>RF Characteristics:</b>	C denotes Circular Polarized	H denotes Horizontal Polarized	V denotes Vertical Polarized
		Horizontal 3D Beam 43° +/-5°	Vertical 3D Beam 38° +/-2°
	Gain:	12dBi	

<b>Electrical:</b>	Impedance:	50Ω	
	Lightening Protection:	Direct Ground	

<b>Materials:</b>	Cover	ABS	
	Back Plate	Aluminum	
	Mounting Brackets	Metal	

<b>Environmental:</b>	Temperature, Storage:	-94°F to +176°F	-70°C to +80°C
	Temperature, Operating:	-94°F to 131°F	-70°C to +55°C
	Ingress Protection:	IP-65 Non-condensing	

<b>Part Numbers:</b>	<b>915 MHz (USA)</b>	<b>865-868 MHz (Euro)</b>	
	719-1818-12C	719-1818-12C-EU	
	719-1818-12V	719-1818-12V-EU	
	719-1818-12H	719-1818-12H-EU	



**Antennas**

**Model UHF-A99C**

**Model UHF-A99H**

**Model UHF-A99V**

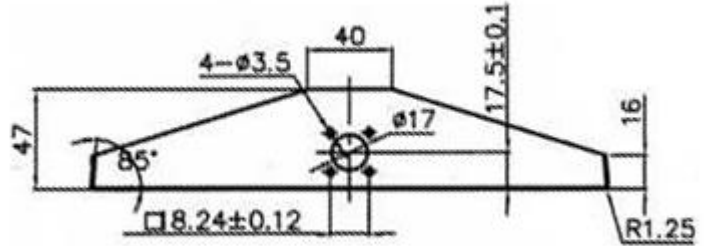

<b>Physical:</b>	Dimensions (Housing Only):	9.75" x8.5" x2.25"	242mm x 238mm x 60mm
	Weight (w/mounting hardware):	2.3 lbs.	1 KG
	Connector:	N Type (Female)	

<b>RF Characteristics:</b>	C denotes Circular Polarized	H denotes Horizontal Polarized	V denotes Vertical Polarized
		Horizontal 3D Beam 65° +/-5°	Vertical 3D Beam 60° +/-2°
	Gain:	9dBi	

<b>Electrical:</b>	Impedance:	50Ω	
	Lightening Protection:	Direct Ground	

<b>Materials:</b>	Cover	ABS	
	Back Plate	Aluminum	
	Mounting Brackets	Metal	

<b>Environmental:</b>	Temperature, Storage:	-94°F to +176°F	-70°C to +80°C
	Temperature, Operating:	-94°F to 131°F	-70°C to +55°C
	Ingress Protection:	IP-53 Non-condensing	

<b>Part Numbers:</b>	<b>915 MHz (USA)</b>	<b>865-868 MHz (Euro)</b>	
	719-0909-09C	719-0909-09C-EU	
	719-0909-09V	719-0909-09V-EU	
	719-0909-09H	719-0909-09H-EU	



**Antennas**

**Model UHF-A78C**

**Model UHF-A78H**

**Model UHF-A78V**

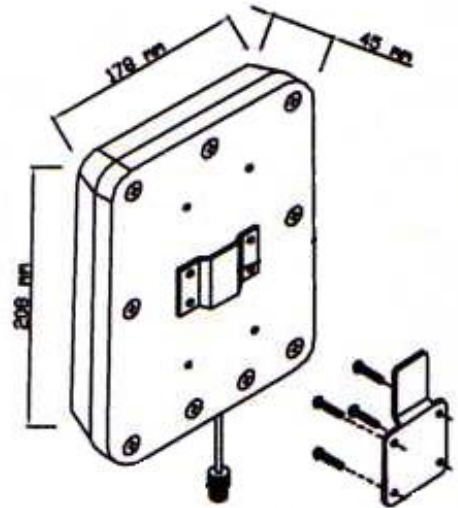

<b>Physical:</b>	Dimensions:	7" x 8.2" x 1.77"	208mm x 178mm x 45mm
	Weight:	11 oz.	308 grams
	Connector:	N Type (Female)	

<b>RF Characteristics:</b>	C denotes Circular Polarized	H denotes Horizontal Polarized	V denotes Vertical Polarized
		Horizontal 3D Beam 70° +/-5°	Vertical 3D Beam 50° +/-2°
	Gain:	7dBi	

<b>Electrical:</b>	Impedance:	50Ω	
	Lightening Protection:	Direct Ground	

<b>Materials:</b>	Cover	ABS	
	Back Plate	Aluminum	
	Mounting Bracket	Aluminum	

<b>Environmental:</b>	Temperature, Storage:	-94°F to +176°F	-70°C to +80°C
	Temperature, Operating:	-94°F to 131°F	-70°C to +55°C
	Ingress Protection:	IP-53 Non-condensing	

<b>Part Numbers:</b>	<b>915 MHz (USA)</b>	<b>865-868 MHz (Euro)</b>	
	719-0708-07R	719-0708-07R-EU	
	719-0708-07V	719-0708-07V-EU	
	719-0708-07H	719-0708-07H-EU	



## Antenna

## Model UHF-A3304-12H



<b>Physical:</b>	Dimensions:	33" x 4" x 1"	833mm x 97mm x 29mm
	Weight:	2 lbs.	920 grams
	Connector:	SMA	
<b>RF Characteristics:</b>	C denotes Circular Polarized	H denotes Horizontal Polarized	V denotes Vertical Polarized
		Horizontal 3D Beam 60° +/-5°	Vertical 3D Beam 30°
	Gain:	10dBi	
<b>Electrical:</b>	Impedance:	50Ω	
	Lightening Protection:	Direct Ground	
<b>Materials:</b>	Cover	GFRP	
		(Glass Fiber Reinforced Polymer)	
<b>Environmental:</b>	Temperature, Storage:	-94°F to +176°F	-70°C to +80°C
	Temperature, Operating:	-94°F to 131°F	-70°C to +55°C
	Ingress Protection:	IP-65 Non-condensing	
<b>Part Numbers:</b>	<b>915 MHz (USA)</b>	<b>865-868 MHz (Euro)</b>	
	719-3304-12H-10	719-3304-12H-10-EU	



**Antenna**

**Model UHF-A55C**



<b>Physical:</b>	Dimensions:	5" x 5" x 0.79"	128mm square x 20mm
	Weight (with cable):	8.4 oz.	238 grams
	Connector:	SMA female	
<b>RF Characteristics:</b>	Polarization:	Circular	100° Horizontal Beam
	Gain:	5.5dBi	
<b>Electrical:</b>	Impedance:	50Ω	
	Lightening Protection:	Direct Ground	
<b>Material:</b>		ASA with UV Protection	Ultra Heavy Duty
<b>Environmental:</b>	Temperature, Storage:	-94°F to +176°F	-70°C to +80°C
	Temperature, Operating:	-94°F to 167°F	-70°C to +75°C
	Ingress Protection:	IP-65 Non-condensing	
<b>Part Numbers:</b>	<b>915 MHz (USA)</b>	<b>865-868 MHz (Euro)</b>	
	719-0505-55C	719-0505-55C-EU	

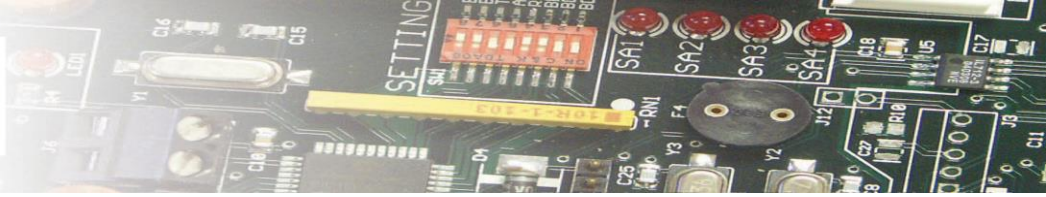

**Antenna**

**Model UHF-A55V**

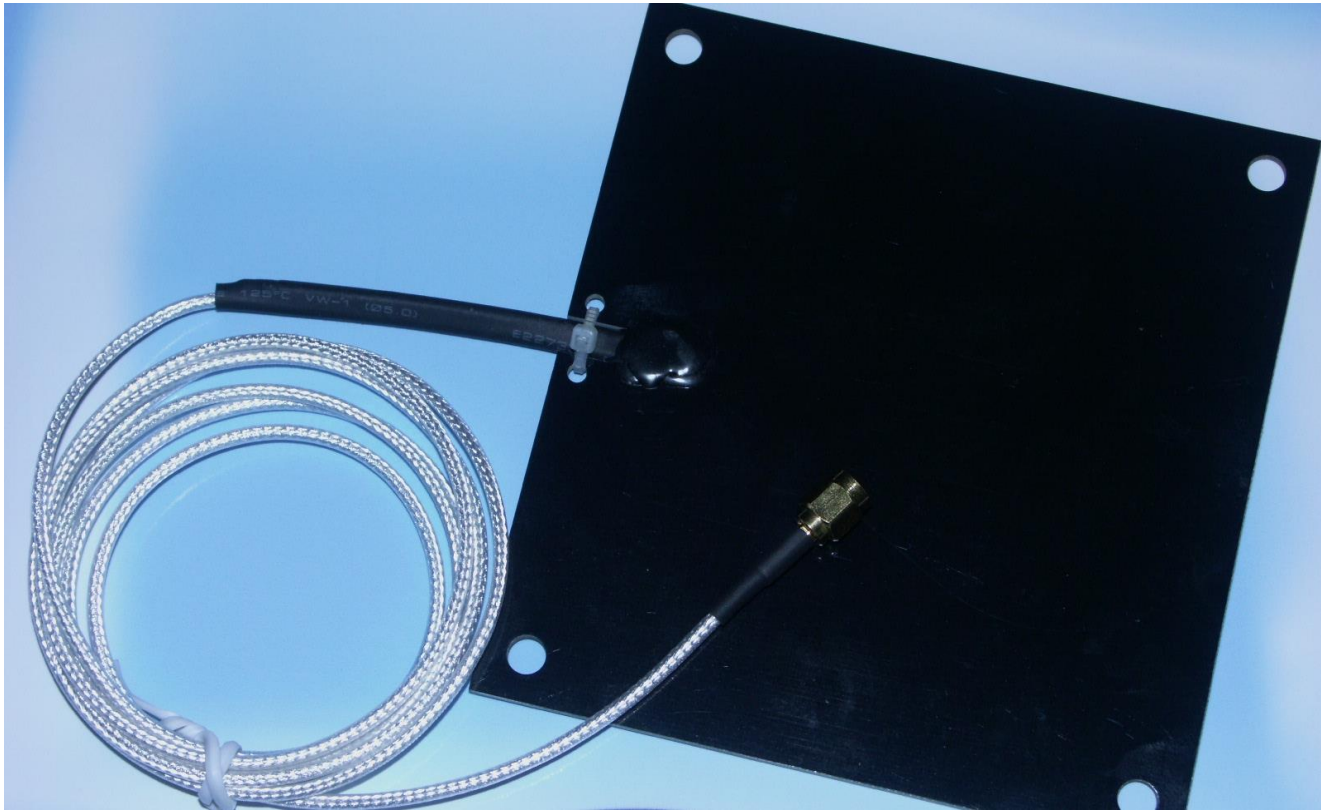

<b>Physical:</b>	Dimensions:	4.75" x 4.735" x 0.0625"	120mm X 112mm x 2mm
	Weight (with cable):	2.4 oz.	70 grams
	Connector:	SMA	

<b>RF Characteristics:</b>	V denotes Vertical Polarization	Horizontal Beam 360°	Vertical Beam 62° +/-2°
	Gain:	2dBi	

<b>Electrical:</b>	Impedance:	50Ω	
	Lightening Protection:	Direct Ground	

<b>Material:</b>	FR4		
------------------	-----	--	--

<b>Environmental:</b>	Temperature, Storage:	-94°F to +176°F	-70°C to +80°C
	Temperature, Operating:	-94°F to 167°F	-70°C to +75°C
	Ingress Protection:	IP-53 Non-condensing	

<b>Part Numbers:</b>	<b>915 MHz (USA)</b>	<b>865-868 MHz (Euro)</b>	
	719-0505-02V	719-0505-02V-EU	

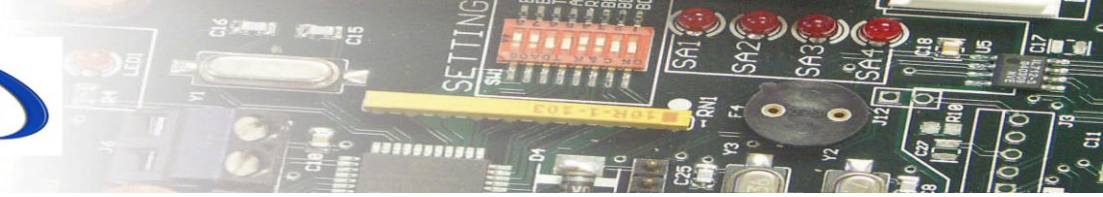

**Model UHF-A115226-C**

**Antennas**

**Model UHF-A4716-C**



<b>Physical:</b>		<b>A115226-C</b>	<b>A4716-C</b>
	Dimensions:	4.53" x 0.87" x 0.24"	1.85" dia. x .63" thick
		115mm x 22mm x 6mm	47mm dia. x 16mm thick
	Weight:	0.7 oz. – 19 grams	1.4 lbs. - .635 kg
	Connector:	SMA or MMCX	SMA or MMCX
	Cable:	RG-174 16 inches	RG-174 8 inches
	Mounting:	Epoxy or glue	Rear hex mount
<b>RF Characteristics:</b>	C denotes Circular Polarization		
	Gain:	A115226-C = 2.5dBi	A4716-C = 2dBi
<b>Electrical:</b>	Impedance:	50Ω	
	Lightening Protection:	Direct Ground	
<b>Material:</b>		A115226-C = PPS	A4716-C = ABS
<b>Environmental:</b>	Temperature, Storage:	-94°F to +176°F	-70°C to +80°C
	Temperature, Operating:	-94°F to 167°F	-70°C to +75°C
	Ingress Protection:	A115226-C = IP-53	A4716-C = up to IP67
<b>Part Numbers:</b>	<b>915 MHz (USA)</b>	<b>865-868 MHz (Euro)</b>	
	719-4716-02C	719-4716-02C-EU	
	719-115226-C	719-115226-C-EU	



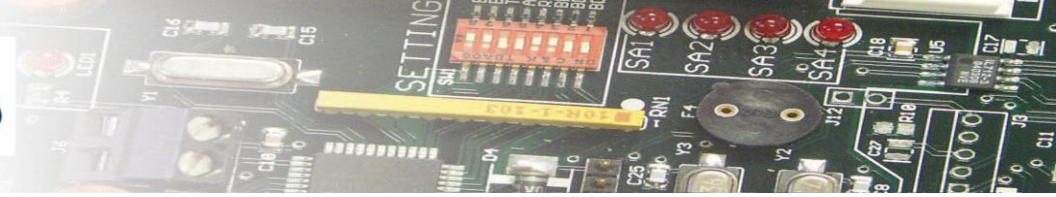

**Antenna Models** (left to right)

**UHF-A32M05C**

**UHF-A4030C**

**UHF-A3205C**

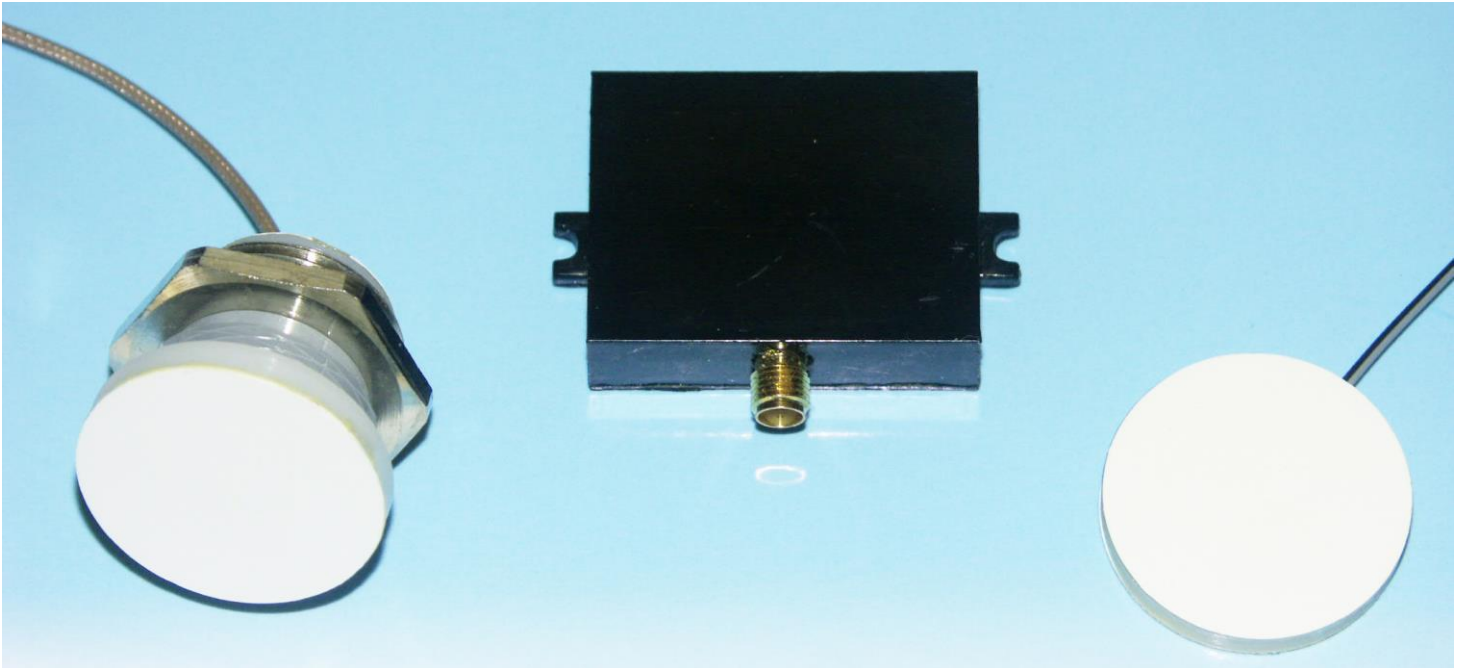

	Dimensions:	Gain:	Cable:
<b>Model A32M05C</b>	32 x 54mm (M25 hex nut)	0.5dBi	RG178
<b>Model A4030C</b>	40 x 30 x 13mm (dog ears)	0.5dBi	RG178
<b>Model A3205C</b>	32 x 5mm (sticky backing)	0.5dBi	RG178

<b>Physical:</b>	Polarization:	C denotes Circular Polarized	
	Connector:	SMA	
	Materials:	ABS	

<b>Electrical:</b>	Impedance:	50Ω	
	Lightening Protection:	Direct Ground	

<b>Environmental:</b>	Temperature, Storage:	-94°F to +176°F	-70°C to +80°C
	Temperature, Operating:	-94°F to 131°F	-70°C to +55°C
	Ingress Protection:	IP-67	

<b>Part Numbers:</b>	<b>915 MHz (USA)</b>	<b>865-868 MHz (Euro)</b>		
	<b>Model A32M05C</b>	719-3205-.5C-Hex	719-3205-.5C—Hex-EU	
	<b>Model A4030C</b>	719-4030-.5C	719-4030-.5C-EU	
	<b>Model A3205C</b>	719-3205-.5C	719-3205-.5C-EU	



**Antenna Models      UHF-A25C    UHF-A36C    UHF-A45C    UHF-A64C    UHF-A80C**

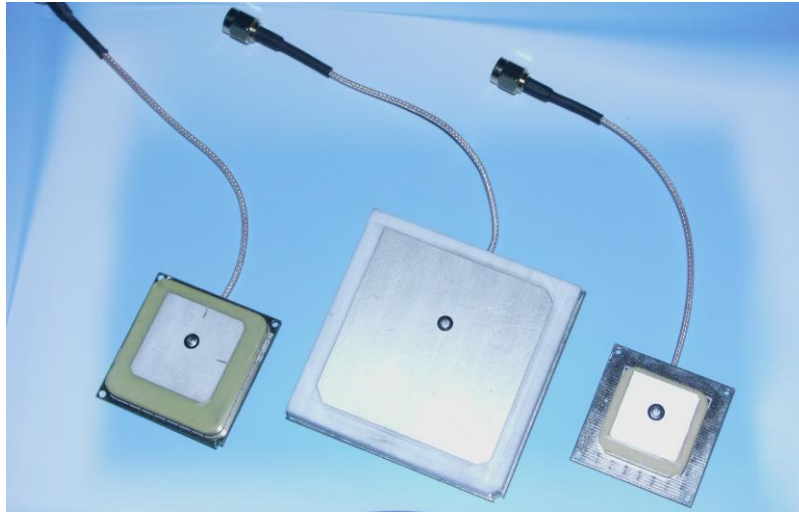

	Dimensions:	Gain:	
<b>Model A25C</b>	25 x 25 x 4mm on 35mm backing	2dBi	
<b>Model A36C</b>	36 x 36 x 4mm on 40mm backing	2dBi	
<b>Model A45C</b>	45 x 45 x 6mm on 65mm backing	3dBi	
<b>Model A64C</b>	64 x 64 x 6mm on 65mm backing	4dBi	
<b>Model A80C</b>	80 x 80 x 6mm on 120mm backing	5.5dBi	

<b>Physical:</b>	Polarization:	C denotes Circular Polarized	
	Connector:	SMA	
	Materials:	Ceramic on Aluminum Back	

<b>Electrical:</b>	Impedance:	50Ω	
	Lightening Protection:	Direct Ground	

<b>Environmental:</b>	Temperature, Storage:	-94°F to +176°F	-70°C to +80°C
	Temperature, Operating:	-94°F to 131°F	-70°C to +55°C
	Ingress Protection:	IP-65	

<b>Part Numbers:</b>	<b>915 MHz (USA)</b>	<b>865-868 MHz (Euro)</b>	
<b>Model A25C</b>	719-2525-02C	719-2525-02C-EU	
<b>Model A36C</b>	719-3636-02C	719-3636-02C-EU	
<b>Model A45C</b>	719-4545-03C	719-4545-03C-EU	
<b>Model A64C</b>	719-6464-04C	719-6464-04C-EU	
<b>Model A80C</b>	719-8080-55C	719-8080-55C-EU	



## FR4 Pallet Tags

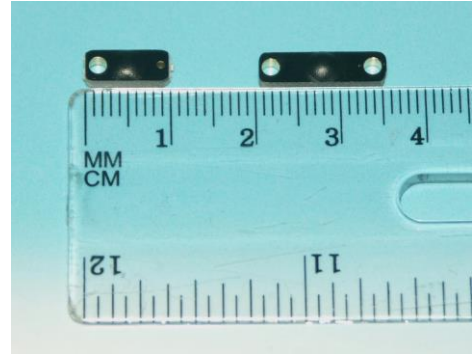
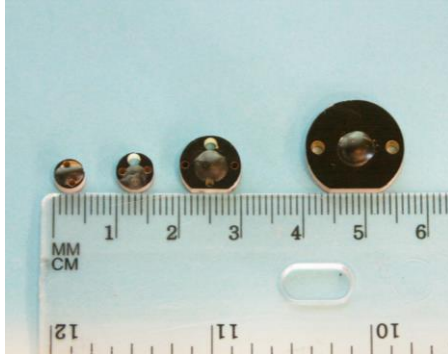

Model Number	Part Number	Description (All Read Ranges Stats On Metal)	Read Range A99H 9dBi	Read Range A55C 5.5dBi	Read Range A64C 4dBi
F05	807-0001-F05	5mm diameter x 4mm w/mounting holes	30"	9"	5"
F10	807-0001-F10	10mm diameter x 4mm w/mounting holes	32"	24"	14"
F16	807-0001-F16	16mm diameter x 4mm w/mounting holes	12'	50"	30"
F40	807-0001-F40	40mm diameter x 4mm w/mounting holes			
F0603	807-0001-F0603	6x03mm w/mounting hole			
F1004	807-0001-F1004	10x04mm w/mounting hole	4.5'	9"	16"
F1504	807-0001-F1504	15x04mm w/mounting holes	5'	20"	24"
F1806	807-0001-F1806	18x06mm, peel & stick backing	36"	15"	35"
F2208	807-0001-F2208	22x08mm, peel & stick backing	13'	34"	34"
F3613	807-0001-F3613	36x13mm, peel & stick backing	15'	5'	4'
F5313	807-0001-F5313	53x13mm, peel & stick backing	20'	5'	4'
F6604	807-0001-F6604	66x04mm, peel & stick backing, w/mnt holes			
F7020	807-0001-F7020	70x20mm, peel & stick backing, w/mnt holes	23'	13'	7'
F9005	807-0001-F9005	90x05mm, peel & stick backing, w/mnt holes	15'	6'	5'
F9008	807-0001-F9008	90x08mm, peel & stick backing, w/mnt holes	15'	6'	5'
F9011	807-0001-F9011	90x11mm, peel & stick backing, w/mnt holes	21'	5.5'	5'
F9525	807-0001-F9525	95x25mm, peel & stick backing, w/mnt holes	25'	13'	8'
F11009	807-0001-F11009	110x09mm, P&S, w/mnt holes, not for metal	30'	18'	12'

<b>Memory:</b>	Sizes (chip dependent):	96, 128, 512, 1k, 2k, 8k bits	100k write cycles max
	Standard:	EPC Class1 Gen2	ISO 18000-6C
	Frequency:	902 – 928 MHz (North America)	860 – 870 MHz (EU, Japan)

<b>Mechanical:</b>	Tag Material:	FR4	
	Sticker:	3M9495LE	

<b>Environmental:</b>	Temp, Tag, Storage:	-40°F to +392°F	-40°C to +200°C
	Temp, Sticker:	-40°F to +302°F	-40°C to +150°C
	Ingress Protection:	IP68	

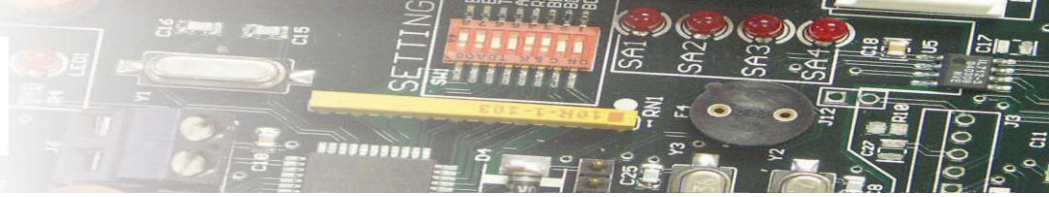

**ABS Pallet  
Tags**



Model Number	Part Number	Description - M = Metal Mount MG = Magnetic HT = High Temp	Read Range A99H 9dBi	Read Range A55C 5.5dBi	Read Range A64C 4dBi
A20	807-0002-A20	ABS, yellow, 20mm diameter x 2.5mm	6"	6"	3"
A5252M	807-0002-A5252M	ABS, Metal Mount, Light Grey, 52x52x10mm, w/mounting holes	10' on Metal 1' Free Air	4.5' on Metal 10" Free Air	2' on Metal 4" Free Air
A5316M	807-0002-A5316M	ABS, Metal Mount, Light Grey, 53x16x9mm, w/mounting holes	22' on Metal 2' Free Air	8' on Metal 1' Free Air	4' on Metal 3" Free Air
A5316M-MG	807-0002-A5316M-MG	ABS, Metal Mount, Light Grey, 53x16x9mm, mounting holes & magnetic	26' on Metal 2' Free Air	12' on Metal 1' Free Air	8' on Metal 3" Free Air
A5208	807-0002-A5208	ABS Round Tag, 52mm dia. x 8mm	8'	5'	2'
A6332-TANK	807-0002-A6332	ABS Orange Tank Tag, Metal Mount 63x32x10mm, peel & stick	23' on Metal 17' Free Air	8' on Metal 6' Free Air	3' on Metal 3' Free Air
A7931M	807-0002-A7931M	ABS, Metal Mount, Dark Grey, 79x31x9mm, w/mounting holes	4' on Metal 6' Free Air	4' on Metal 2' Free Air	1' on Metal 10" Free Air
A10324M	807-0002-10324M	ABS, Metal Mount, Dark Grey, 103x24x8mm, w/mounting holes	11' on Metal 15' Free Air	6' on Metal 10' Free Air	3' on Metal 4' Free Air
A11732	807-0002-A11732	ABS, Dark Grey, 117x32x8mm, w/holes	17'	10'	3'
A13520M	807-0002-A13520M	ABS, Metal Mount, Blue, 135x20x15mm, w/mounting holes	13' on Metal 30' Free Air	7' on Metal 12' Free Air	3' on Metal 8' Free Air
A15023	807-0002-A15023	ABS, Metal Mount, Light Grey, 150x23x18mm, w/mounting holes	13' on Metal 31' Free Air	10' on Metal 13' Free Air	6' on Metal 10' Free Air
A15023-HT	807-0002-A15023-HT	ABS, Black, 150x23x18mm, w/mounting holes, High Temp 200c	13' on Metal 31' Free Air	10' on Metal 13' Free Air	6' on Metal 10' Free Air
A15532M	807-0002-A15532M	ABS, Metal Mount, Dark Grey, 155x32x10mm, w/mounting holes	36' on Metal 31' Free Air	12' on Metal 9' Free Air	8' on Metal 5' Free Air

<b>Memory:</b>	Sizes (chip dependent):	96, 128, 512, 1k, 2k, 8k bits	100k write cycles max
	Standard:	EPC Class1 Gen2	ISO 18000-6C
	Frequency:	902 – 928 MHz (N. America)	865 – 867 MHz (EU)
<b>Mechanical:</b>	Tag material:	ABS	
<b>Environmental:</b>	Temp, High Temp Tags	See high temp Tag specs next page	
	Temp, Op., standard Tags	-40°F to +185°F	-40°C to +85°C
	Ingress Protection:	IP67 & IP68, Tag dependent	



## High Temperature Tags

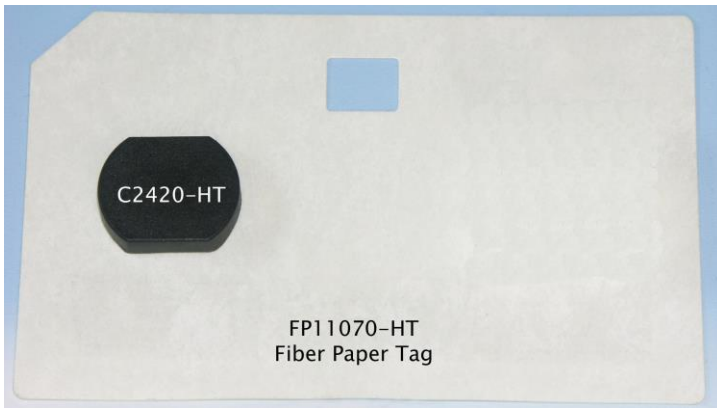

Model Number	Part Number	Description	Read Range A99H 9dBi	Read Range A55C 5.5dBi	Read Range A64C 4dBi
Fxxxx	See page 19	All FR4 Tags can survive <b>200°C</b> (392°F) indefinite	See	Page	17
Cxxxx	See page 22	All Ceramic Tags can survive <b>230°C</b> (392°F) indefinite	See	Page	20
C2420-HT	807-0004-C2420-HT	Ceramic w/PPA housing, 24x20mm, High Temp <b>200°C</b> 10 hours, <b>230°C</b> 1 hour	16' on Metal 7' Free Air	13' on Metal 5' Free Air	2' on Metal 20" Free Air
A15023-HT (page 20)	807-0002-A15023-HT	ABS, Metal Mount, Black, 150x23x18mm, w/mounting holes, High Temp <b>200°C</b> 1 hour	13' on Metal 31' Free Air	10' on Metal 13' Free Air	6' on Metal 10' Free Air
FP11070-HT	807-0021-11070-HT	Fibrous Paper Tag, 110mm x 70mm x 0.2mm, <b>230°C</b> 1 hour	29'	10'	5'
A5027M-HT	807-0002-A5027M-HT	ABS/Nylon High Temp <b>300°C</b> Tag, Metal Mount, charcoal, 50x27x17mm	12' on Metal	11' on Metal	6' on Metal
A7628M-HT	807-0002-A7628M-HT	ABS/Nylon High Temp <b>300°C</b> Tag, Metal Mount, charcoal, 76x28x17mm	12' on Metal	11' on Metal	6' on Metal
W2525M-HT	807-0016-W2525M-HT	Weldable Metal Mount High Temp <b>200°C</b> Tag, 25x25x13mm			
W3825M-HT	807-0016-W3825M-HT	Weldable Metal Mount High Temp <b>200°C</b> Tag, 38x25x13mm	10' on Metal	5' on Metal	3' on Metal
W5944M-HT	807-0016-W5944M-HT	Weldable Metal Mount High Temp <b>300°C</b> Tag, 59x44x15mm	9' on Metal	7' on Metal	6' on Metal
W6154M-HT	807-0016-W6154M-HT	Weldable Metal Mount High Temp <b>400°C</b> Tag, 61x54x17mm	5' on Metal	4' on Metal	4' on Metal
S240-HT	807-0017-S240-HT	Eyelet Strap High Temp <b>250°C</b> Tag, clear Teflon, 240mm length x 7.86mm dia.	20' on Metal	16' on Metal	6' on Metal

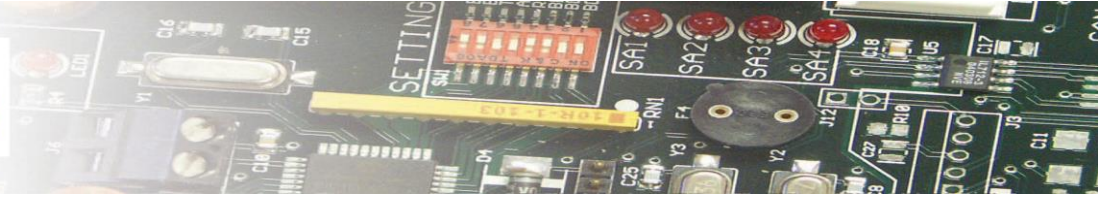

## Ceramic Metal Mount Tags

## Temperature Sensing Tags



Model Number	Part Number	Description	Read Range A99H 9dBi	Read Range A55C 5.5dBi	Read Range A64C 4dBi
			↓ All Read	Range Stats	On Metal ↓
2510-TMP	807-0023-2510-TMP	Model 2510-TMP Temperature Sensing Tag, Metal Mount	19'	10'	6'
C0202	807-0004-C0202	Ceramic, 1.8x1.8x10mm stick, 230°C	0	0	0 2" w/A25C
C0404	807-0004-C0404	Ceramic, 4x4x3mm cube, 230°C	24"	16"	6"
C0505	807-0004-C0505	Ceramic, 5x5x3mm cube, 230°C	24"	18"	7"
C10	807-0004-C10	Ceramic, 10mm diameter x 2mm, 230°C	28"	18"	12"
C16	807-0004-C16	Ceramic, 16mm diameter x 3mm, 230°C	5'	30"	28"
C1309	807-0004-C1309	Ceramic, 13x9x3mm, 230°C	2'	18"	12"
C1909	807-0004-C1909	Ceramic, 19x9x3mm, 230°C	10'	20"	3'
C2420-HT	807-0004-C2420-HT (see page 15)	Ceramic w/PPA housing, 24x20mm, High Temp 200°C 10 hours, 230°C 1 hour	20'	11'	6'
C2509	807-0004-C2509	Ceramic, 25x9x3mm, 230°C	13'	20"	3'
C2525	807-0004-C2525	Ceramic, 25mm square x 3mm, 230°C	15'	4'	6'
C3030M	807-0004-C3030M	Ceramic, 30mm square x 3mm	17'	6'	8'
C5151	807-0004-C5151	High Temp Ceramic, 51x51x3mm, 320°C 5/min, 300°C 45/min, 260°C 90/min	20' Free Air	4' Free Air	3' Free Air
C20020	807-0004-C20020	High Temp Ceramic, 200x20x3mm, 320°C 5/min, 300°C 45/min, 260°C 90/min	40' Free Air	16' Free Air	12' Free Air

<b>Memory:</b>	Sizes (chip dependent):	96, 128, 512, 1k, 2k, 8k bits	100k write cycles max
	Standard:	EPC Class1 Gen2	ISO 18000-6C
	Frequency:	902 – 928 MHz (North America)	860 – 870 MHz (EU, Japan)

<b>Mechanical:</b>	Tag Material:	FR4	
	Sticker:	3M9495LE	

<b>Environmental:</b>	Temp, Storage:	-40°F to +392°F	-40°C to +200°C
	Temp, Operating:	-40°F to +302°F	-40°C to +150°C
	Ingress Protection:	IP68	

<b>Temperature Sensing Tag:</b>	Tag Material:	Ceramic	
	Temperature Reports:	-40°C to 145°C	

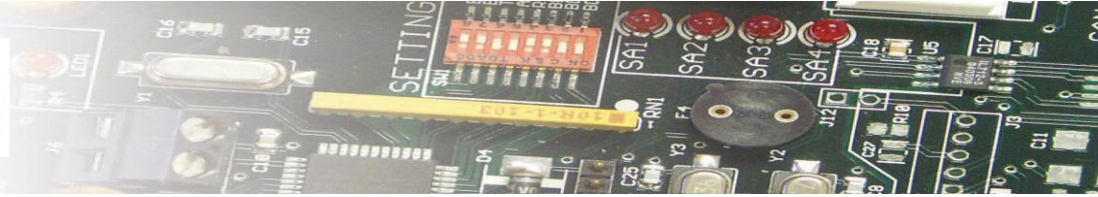

**Metal Bolts**

**Plastic Bolts**

**Nail Tags**

**Threaded Plugs**



Model Number	Part Number	Description	Read Range A99H 9dBi	Read Range A55C 5.5dBi	Read Range A64C 4dBi
BT05 (top right)	807-0006-BT05	Metal Bolt Tag Shaft 13mm dia. x 64mm length, 20mm head Shaft 0.50" dia. x 2.5" length, 5/8" head	28"	18"	12"
BT1225 (top center)	807-0006-BT1225	Metal Bolt Tag Shaft 12mm dia. x 15mm length, 25mm head Shaft 0.50" dia. x 9/16, 1.0" head	5'	2.5'	2'
PBT2070 (top left)	807-0006-PBT2070	ABS Grey or White Bolt Tag Shaft 20mm dia. x 70mm length, 37mm head Shaft 0.75" dia. x 2.75" length, 1.25" head	2'	1'	6"
PBT1438 (orange)	807-0006-PBT1438	ABS Orange Bolt Tag 14mm diameter x 38mm length, w/nut	6"	4"	2"
ST10 (white top)	807-0006-ST10	ABS White Screw Tag Shaft 10mm dia. x 51mm length, 13mm head Shaft 7/16" dia. x 2" length, 0.50" head	6"	2'	3"
ST1208	807-0006-ST1208	ABS Threaded Black Plug Tag 12mm diameter x 8mm tall	0	0	0 1" w/A25C
ST3015 (bot. right)	807-0006-ST3015	ABS Threaded Black Plug Tag 30mm diameter x 15mm tall	7'	3'	2'
N4209	807-0006-N4209	Plastic Nail Tag, black, 42mm x 9mm dia.	2'	4"	4"
N3706	807-0006-N3706	Plastic Nail Tag, white 37mm x 6mm dia.	3'	12"	8"

<b>Memory</b>	Sizes (chip dependent):	96, 128, 512, 1k, 2k, 8k bits	100k write cycles max
	Standard:	EPC Class1 Gen2	ISO 18000-6C
	Frequency:	902 – 928 MHz (North America)	860 – 870 MHz (EU, Japan)

<b>Mechanical</b> Tag Material:	BTxx	ST30	ST10	BT2020
	Steel	PA-6	ABS	Steel with PPT Head

<b>Environmental</b> Temperature, Storage:	BTxx	ST30	ST10	BT2020
	-40°F to +248°F -40°C to +120°C	-40°F to +248°F -40°C to +120°C	-20°F to +185°F -20°C to +85°C	-40°F to +248°F -40°C to +120°C
Temperature, Operating:	-40°F to +257°F -40°C to +125°C	-40°F to +257°F -40°C to +125°C	-20°F to +176°F -20°C to +80°C	-40°F to +257°F -40°C to +125°C
	Ingress Protection:	IP68	IP68	IP67

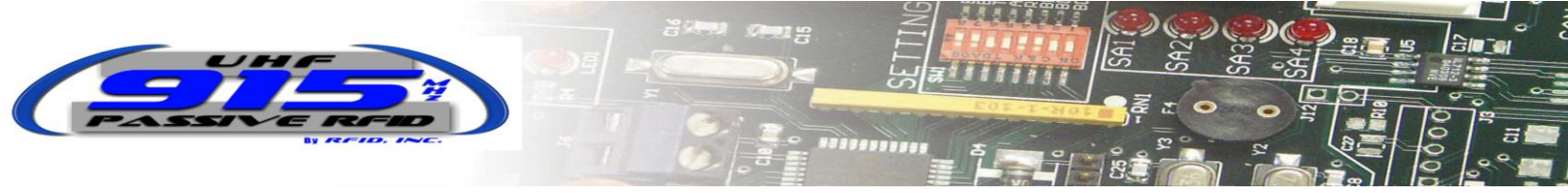

## Vehicle Tags – Windshield, Headlight, Metal Mount



Model Number	Part Number	Description	Read Range A99H 9dBi	Read Range A55C 5.5dBi	Read Range A64C 4dBi
WS8654 (center)	807-0008-WS8654	Windshield Tag, printable label, Self-destruct tamperproof 86x54mm	22'	11'	6'
IW9508 (left)	807-0011-IW9508	Head Light or Windshield Tag, clear/flexible, Self-destruct tamperproof, 95x08mm	32'	22'	7'
P13385 (right)	807-0003-P13385	PVC Rearview Mirror Hang Tag, 133x85mm	22'	11'	5.5'

Memory:	Sizes (chip dependent):	96, 128, 512, 1k, 2k, 8k bits	100k write cycles max
	Standard:	EPC Class1 Gen2	ISO 18000-6C
	Frequency:	902 – 928 MHz (North America)	860 – 870 MHz (EU, Japan)

Mechanical:	Tag Material:	PET w/aluminum antenna	

Mechanical:	WS8654	IW9508	P13385
Material:	PET + Aluminum Ant	PET + Aluminum Antenna	PVC
IP:	IP67	IP67	IP67
Operating Temp:	-40°C to +85°C	-40°C to +85°C	-40°C to +85°C





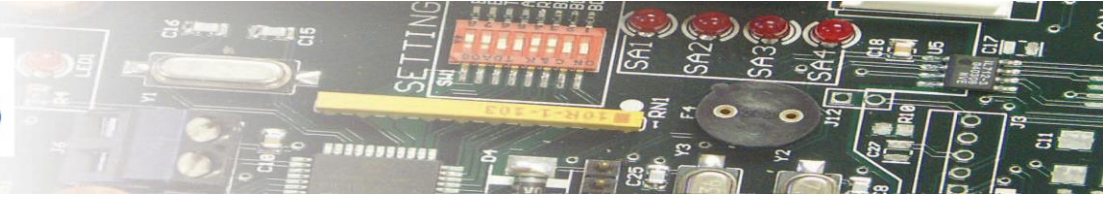

## Metal Mount Labels

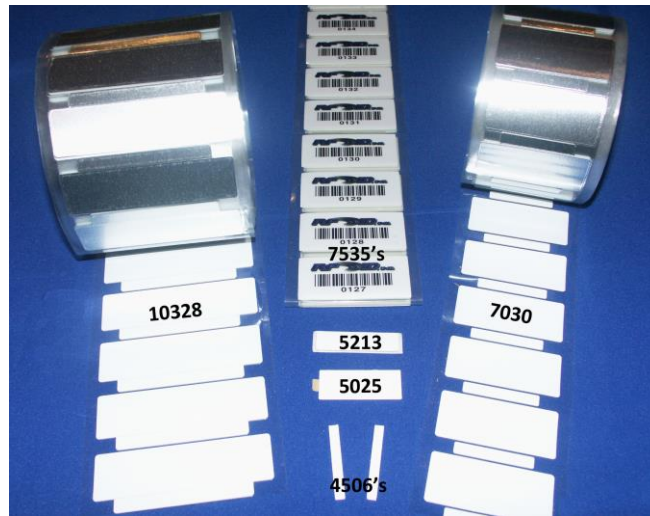

Model Number	Part Number	Description	Read Range A99H 9dBi	Read Range A55C 5.5dBi	Read Range A64C 4dBi
			↓ All Read	Range Stats	On Metal ↓
ML4506	807-0020-ML4506	Metal Mount Label Tag, 1.77" x 0.22" x 0.03" (45x6x0.86mm), on reel of 500	18"	15"	10"
ML5020	807-0020-ML5020	Metal Mount Label Tag, 1.97" x 0.79" x 0.03" (50x20x0.86mm), on reel of 500	7'	5'	3'
ML5025	807-0020-ML5025	Metal Mount Label Tag, 1.97" x 0.98" x 0.03" (50x25x0.86mm), on reel of 500	10'	5.5'	4'
ML5213	807-0020-ML5213	Metal Mount Label Tag, 2.05" x 0.51" x 0.03" (52x13x0.86mm), on reel of 500	12"	12"	16"
ML5819	807-002-ML5819	Metal Mount Label Tag, 2.28" x 0.75" x 0.03" (58x19x0.86mm), on reel of 500			
ML6535	807-0020-ML7535	Metal Mount Label Tag, 2.56" x 1.375" x 0.04", (65x35x1mm), on reel of 500	25'	17'	8'
ML8343	807-0020-ML8343	Metal Mount Label Tag, 3.27" x 1.69" x 0.03" (83x43x0.86mm), on reel of 500			
ML9525	807-0020-ML9525	Metal Mount Label Tag, 3.74" x 0.98" x 0.03" (95x25x0.86mm), on reel of 500	5'	5'	3'
ML10328	807-0020-ML10328	Metal Mount Label Tag, 4.0" x 0.1.10" x 0.03" (103x28x0.86mm), on reel of 500	10'	5.5'	4'
ML10238	807-0020-ML10238	Metal Mount Label Tag, 4" x 1.5" x 0.03" (102x38x0.76mm), on reel of 500	7'	6'	4.5'

<b>Memory:</b>	Sizes (chip dependent):	96, 128, 512, 1k, 2k, 8k bits	100k write cycles max
	Standard:	EPC Class1 Gen2	ISO 18000-6C
	Frequency:	902 – 928 MHz (North America)	860 – 870 MHz (EU, Japan)

<b>Mechanical:</b>	Tag Material:	White thermal transfer PET	High performance adhesive
--------------------	---------------	----------------------------	---------------------------

<b>Environmental:</b>	Temp, Storage:	-40°F to +185°F	-40°C to +85°C
	Temp, Operating:	-40°F to +185°F	-40°C to +85°C
	Ingress Protection:	IP65	

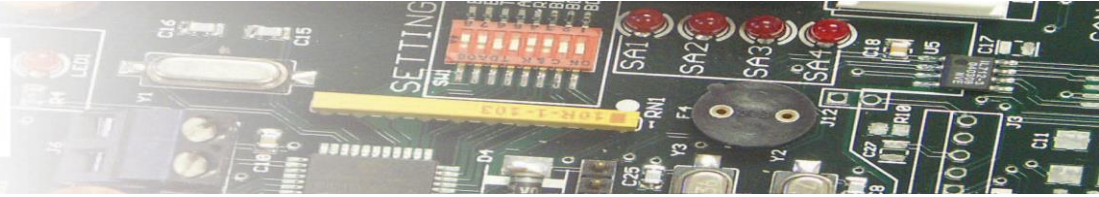

## Roll Stock Labels



## Small Peel & Stick Labels (PSL)

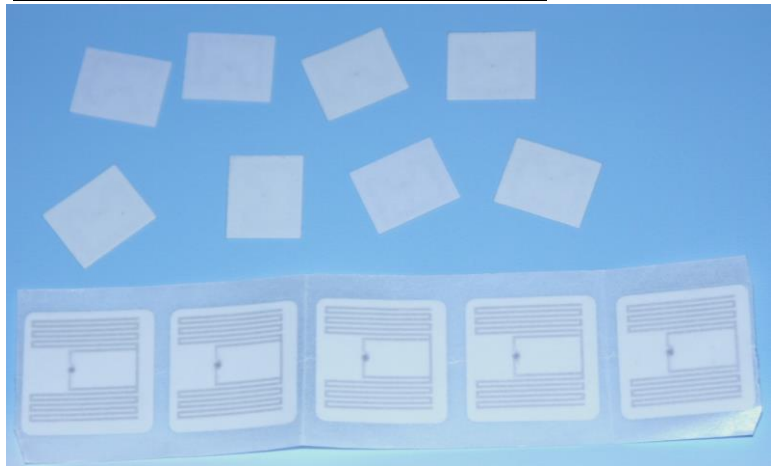

Model Number	Part Number	Description	Read Range A99H 9dBi	Read Range A55C 5.5dBi	Read Range A64C 4dBi
RS3015	807-0019-RS3015	Roll Stock Label, 30x15mm (1.18x0.59")			
RS3535	807-0019-RS3535	Roll Stock Label, 35x35mm (1.38x1.38")	Dependent	Upon	Inlay
RS4025	807-0019-RS4025	Roll Stock Label, 40x25mm (1.57x0.98")	Installed	Into	Label
RS5050	807-0019-RS5050	Roll Stock Label, 50x50mm (1.97x1.97")			
RS5517	807-0019-RS5517	Roll Stock Label, 55x17mm (2.17x0.67")			
RS5726	807-0019-RS5726	Roll Stock Label, 57x26mm (2.25x1.02")	Any	Custom	Size
RS7050	807-0019-RS7050	Roll Stock Label, 70x50mm (2.75x1.97")	Label	Possible	
RS7322	807-0019-RS7323	Roll Stock Label, 73x22mm (2.87x0.87")			
RS8654	807-0019-RS8654	Roll Stock Label, 86x54mm (3.39x2.13")			
RS9595	807-0019-RS9595	Roll Stock Label, 95x95mm (3.74x3.74")			
RS10015	807-0019-RS10015	Roll Stock Label, 100x15mm (3.94x0.59")			
RS10251	807-0019-RS10251	Roll Stock Label, 102x51mm (2x4")			
RS102102	807-0019-RS102102	Roll Stock Label, 102x102mm (4x4")			
RS11012	807-0019-RS11012	Roll Stock Label, 110x12mm (4.33x0.47")			
RS16005	807-0019-RS16005	Roll Stock Label, 160x5mm (6.3x0.20")			
PSL1613	807-0009-PSL1613	Roll Stock Label, 16x13mm (0.63x0.51")			
PSL2525	807-0009-PSL2525	Roll Stock Label, 25x25mm (0.98x0.98")			
PSL21	807-0009-PSL21	Roll Stock Label, 21mm diameter (0.83")			

<b>Memory:</b>	Sizes (chip dependent):	96, 128, 512, 1k, 2k, 8k bits	100k write cycles max
	Standard:	EPC Class1 Gen2	ISO 18000-6C
	Frequency:	902 – 928 MHz (North America)	860 – 870 MHz (EU, Japan)

<b>Mechanical:</b>	Tag Material:	Paper label w/ adhesive backing	PET w/aluminum antenna
--------------------	---------------	---------------------------------	------------------------

<b>Environmental:</b>	Temp, Storage:	-40°F to +185°F	-40°C to +85°C
	Temp, Operating:	-40°F to +185°F	-40°C to +85°C
	Ingress Protection:	IP65	

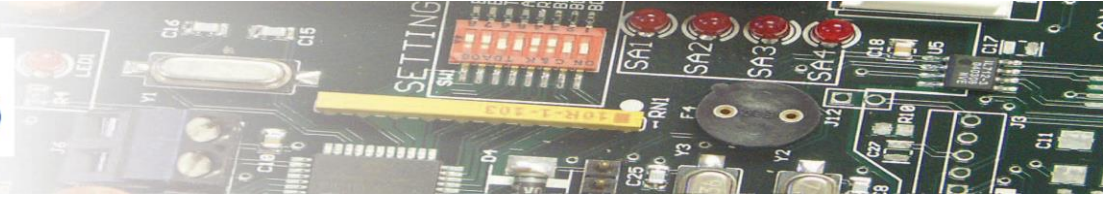

## Inlays

Wet = Sticky Backing

Dry = No Sticky Backing



Model Number	Part Number (use -0010 for Dry)	Description (all measurements = antenna substrate)	Read Range A99H 9dB	Read Range A55C 5.5dB	Read Range A64C 4dB
IW13	807-0011-IW13	Inlay, Wet or Dry, 13mm diameter	6"	2"	2"
IW22	807-0011-IW22	Inlay, Wet or Dry, 22mm diameter	2'	1'	8"
IW27	807-0011-IW27	Inlay, Wet or Dry, 27mm diameter	6'	3.5'	8"
IW1310	807-0011-IW1310	Inlay, Wet or Dry, 13x10mm	2"	2"	2"
IW1815	807-0011-IW1815	Inlay, Wet or Dry, 18x15mm	2'	8"	4"
IW2208	807-0011-IW2208	Inlay, Wet or Dry, 22x08mm	2.5'	1.5'	6"
IW2222	807-0011-IW2222	Inlay, Wet or Dry, 22x22mm	5'	2.5'	1.5'
IW2816	807-0011-IW2816	Inlay, Wet or Dry, 28x16mm	6'	3.5'	20"
IW2910	807-0011-IW2910	Inlay, Wet or Dry, 29x10mm	4'	2.5'	10"
IW3027	807-0011-IW3027	Inlay, Wet or Dry, 30x27mm	6.5'	3.5'	1.5'
IW3418	807-0011-IW3418	Inlay, Wet or Dry, 34x18mm	6'	3'	6"
IW4115	807-0011-IW4115	Inlay, Wet or Dry, 41x15mm	18'	9'	2'
IW4411	807-0011-IW4411	Inlay, Wet or Dry, 44x11mm	14'	6'	2'
IW4444	807-0011-IW4444	Inlay, Wet or Dry, 44x44mm	22'	12'	5'
IW4630	807-0011-IW4630	Inlay, Wet or Dry, 46x30mm	16'	8'	2'
IW4717	807-0011-IW4717	Inlay, Wet or Dry, 47x17mm	22'	14'	7'
IW5030	807-0011-IW5030	Inlay, Wet or Dry, 50x30mm	22'	12'	3.5'
IW5516	807-0011-IW5516	Inlay, Wet or Dry, 55x16mm	8'	3'	16"
IW5714	807-0011-IW5714	Inlay, Wet or Dry, 57x14mm	10'	6'	1.5'
IW5725	807-0011-IW5725	Inlay, Wet or Dry, 57x25mm	18'	9'	2.5'
IW6525	807-0011-IW6525	Inlay, Wet or Dry, 65x25mm	7'	4'	1'
IW7009	807-0011-IW7009	Inlay, Wet or Dry, 70x09mm	19'	16'	8'
IW7014	807-0011-IW7014	Inlay, Wet or Dry, 70x14mm	26'	18'	3'
IW7019	807-0011-IW7019	Inlay, Wet or Dry, 70x19mm	24'	12'	3.5'
IW7606	807-0011-IW7606	Inlay, Wet or Dry, 76x06mm	18'	8'	18"
IW8610	807-0011-IW8610	Inlay, Wet or Dry, 86x10mm	28'	17'	2.5'
IW9311	807-0011-IW9311	Inlay, Wet or Dry, 93x11mm	35'	18'	4.5'
IW9503	807-0011-IW9503	Inlay, Wet or Dry, 95x03mm	35'	17'	3'
IW9508	807-0011-IW9508	Inlay, Wet or Dry, 95x08mm	32'	22'	7'
IW10006	807-0011-IW10006	Inlay, Wet or Dry, 100x06mm	17'	11'	3'
IW10506	807-0011-IW10506	Inlay, Wet or Dry, 105x06mm	22'	12'	2.5'

<b>Mechanical:</b>	Tag Material:	PET w/aluminum antenna
--------------------	---------------	------------------------

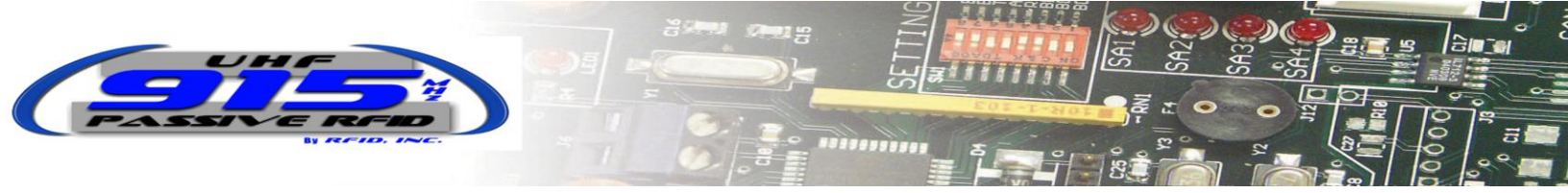

## Employee ID – Lanyards - Wrist Bands – Keyfob - Badges



Model Number	Part Number	Description	Read Range A99H 9dBi	Read Range A55C 5.5dBi	Read Range A64C 4dBi
WB-PB	807-0014-WB-PB	Wrist Band, Patient Style, Blue	10' On Wrist	4' On Wrist	2' On Wrist
WB-PP	807-0014-WB-PP	Wrist Band, Patient Style, Pink	10' On Wrist	4' On Wrist	2' On Wrist
WB-V1	807-0014-WB-V1	Wrist Band, hard plastic w/Velcro band, yellow	16' On Wrist	8' On Wrist	6' On Wrist
KF-Color	807-0012-KF-xx	Keyfob, blue/red/black/red,/orange, round	4'	2'	1'
L5204	807-0022-L5204	Lanyard Tag, with breakaway safety strap	20' On Body	10' On Body	6' On Body
P1770S	807-0077-P8654S	Employee Badge, ISO Card, w/slot, 86X54mm	30'	16'	8'

<b>Memory:</b>	Sizes (chip dependent):	96, 128, 512, 1k, 2k, 8k bits	100k write cycles max
	Standard:	EPC Class1 Gen2	ISO 18000-6C
	Frequency:	902 – 928 MHz (North America)	860 – 870 MHz (EU, Japan)

<b>Mechanical</b> Tag Material:	WB-PB/PP	L5204	P1770S	WB-V1 or KF1
	PVC	Nylon	PVC	ABS

<b>Environmental</b> Temperature, Storage:	WB-PB/PP	L5204	P1770S	WB-V1 or KF1
	-40°F to +185°F -40°C to +85°C	-40°F to +185°F -40°C to +85°C	-40°F to +212°F -40°C to +100°C	-40°F to +212°F -40°C to +100°C
Temperature, Operating:	WB-PB/PP	L5204	P1770S	WB-V1 or KF1
	-40°F to +185°F -40°C to +85°C	-40°F to +185°F -40°C to +85°C	-40°F to +185°F -40°C to +85°C	-40°F to +185°F -40°C to +85°C
Ingress Protection	IP65	IP65	IP67	IP67



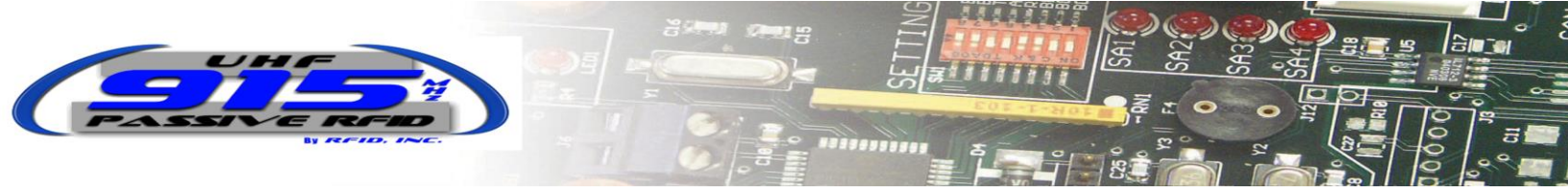

## Laundry Tags



Model Number	Part Number	Description	Read Range A99H 9dBi	Read Range A55C 5.5dBi	Read Range A64C 4dBi
SL3416	807-0015-SL3416	Silicon Laundry Tag, flexible, 34x16mm, white	6'	3'	1.5'
SL5510	807-0015-SL5510	Silicon Laundry Tag, flexible, 55x10mm, white	10'	4.5'	2.5'
SL5525	807-0015-SL5525	Silicon Laundry Tag, flexible, 55x25x2mm, blue	12'	5'	3.5'
SL7435	807-0015-SL7435	Silicon Laundry Tag, flexible, 74x35x2mm, blue	11'	4'	2'

<b>Memory:</b>	Sizes (chip dependent):	96, 128, 512, 1k, 2k, 8k bits	100k write cycles max
	Standard:	EPC Class1 Gen2	ISO 18000-6C
	Frequency:	902 – 928 MHz (North America)	860 – 870 MHz (EU, Japan)

<b>Mechanical:</b>	<b>All Silicon Laundry Tags</b>		
Tag Material:	Flexible Silicon		

<b>Environmental</b>	<b>All Silicon Laundry Tags</b>		
Temperature, Storage:	140°C (60 minutes) 200°C (10 minutes)		
Temperature, Operating:	-40°F to +185°F -40°C to +85°C		
Ingress Protection:	IP68		
Pressure:	500N		
Life Cycle	200 washes		



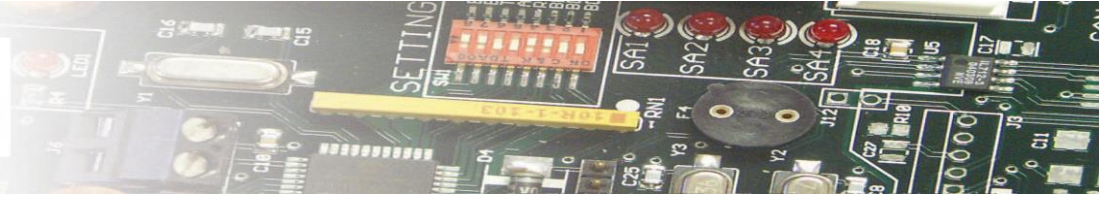

## Asset/Security Tags – Tie Straps – PVC Hang Tags – PVC Stick On – Clip – Tire Tag

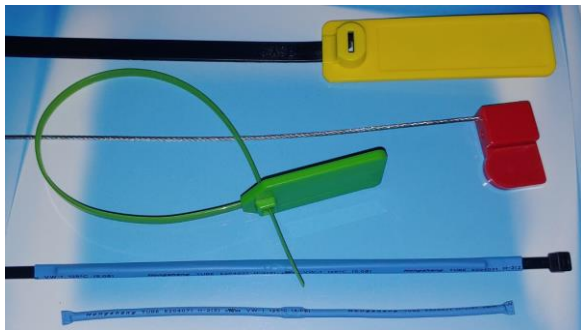

Model Number	Part Number	Description	Read Range A99H 9dBi	Read Range A55C 5.5dBi	Read Range A64C 4dBi
S179	807-0017-S179	Model S179 Embeddable Wraparound Strap Tag, blue, 179 length x 3mm dia.	12'	6'	2'
S360	807-0017-S360	Model S360 Tie Strap Tag, blue/black, 360mm length x 4mm dia.	20'	17'	8'
S3625	807-0017-S3625	Metal Tie Strap Tag, red, 36x25mm main body w/270mm strap	2'	1'	6"
S6028	807-0017-S6028	Plastic Tie Strap Seal Tag, green, 60x28mm main body w/285mm strap, green	12'	12'	6'
S11030	807-0017-S11030	Plastic Tie Strap Seal Tag, blue, yellow or green, 110x30mm main body w/220mm strap	35'	15'	6'
P8025	807-0003-P8025	PVC Stick on Tag, 80x25mm	21'	13'	7'
P5025M	807-0003-P5025M	PVC Stick on Metal Mount Tag, 50x25mm	13'	6'	1'
P6627	807-0003-P6627	PVC Stick on Tag, 66x27mm	18'	9'	3'
P9133	807-0003-P9133	PVC Hang Tag, 91x33mm	26'	16'	8'
P6045	807-0003-P6045	PVC Hang Tag, 60x45mm	22'	12'	3.5'
P3015	807-0003P3015	PVC Hang Tag, 30x15mm	4'	4'	1'
RS2315J	807-0011-00-RS2315J	Jewelry/Asset Label on Roll Stock, 23x15mm	12'	3'	18"
TT8401	807-0021-TT8401	Tire Tag, PCB + Spring Antenna, 84x1mm	12'	7'	3'
RP11055	807-0021-RP11055	Tire Tag, Rubber, 105x55x3mm	19'	10'	6'

<b>Memory:</b>	Sizes (chip dependent):	96, 128, 512, 1k, 2k, 8k bits	100k write cycles max
	Standard:	EPC Class1 Gen2	ISO 18000-6C
	Frequency:	902 – 928 MHz (North America)	860 – 870 MHz (EU, Japan)

Mechanical Tag Material:	S6028 & S11030	RS2315J	TT8401	RP11055
	Polypropylene	PVC Laminate	PCB + Spring	Rubber
Environmental Temperature, Storage:	S6028 & S11030	RS2315J	TT8401	RP11055
	-40°F to +185°F -40°C to +85°C	-40°F to +185°F -40°C to +85°C	-40°F to +185°F -40°C to +85°C	-40°F to +185°F -40°C to +85°C
Environmental Temperature, Operating:	S6028 & S11030	RS2315J	TT8401	RP11055
	-40°F to +185°F -40°C to +85°C	-40°F to +185°F -40°C to +85°C	-40°F to +185°F -40°C to +85°C	-40°F to +185°F -40°C to +85°C
Ingress Protection:	IP67	IP65	IP67	IP67

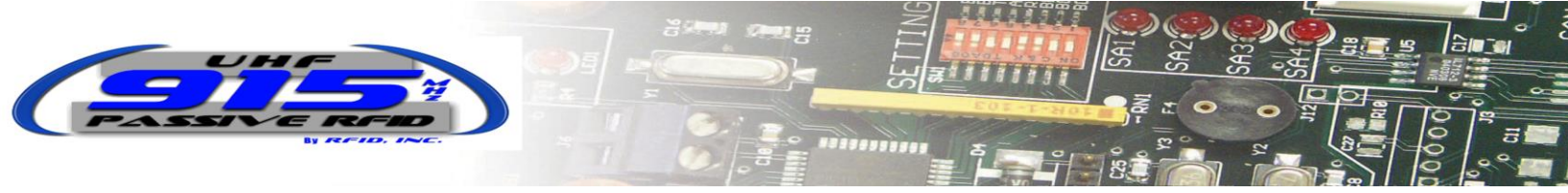

## Animal Ear Tags



## Plant & Alligator Clip Tag



Model Number	Part Number	Description	Read Range A99H 9dBi	Read Range A55C 5.5dBi	Read Range A64C 4dBi
ET32	807-0022-AET32	Animal Ear Tag, 32mm dia.			
ET5419	807-0022-ET5419	Animal Ear Tag, 54x19mm	14'	6'	2'
ET7181	807-0022-ET7181	Animal Ear Tag, 71x81mm	22'	12'	5'
1766-APP	800-0126-50	Ear Tag Applicator	-	-	-
AC7025	807-0005-AC7025	Alligator Clip, Light Gray, 70x25mm	16'	6'	5'
PT15560	807-0007-PT15560	Plant Tag, 155x60mm, ABS	15'	8'	5'

<b>Memory:</b>	Sizes (chip dependent):	96, 128, 512, 1k, 2k, 8k bits	100k write cycles max
	Standard:	EPC Class1 Gen2	ISO 18000-6C
	Frequency:	902 – 928 MHz (North America)	860 – 870 MHz (EU, Japan)

<b>Mechanical:</b>	Animal Ear Tag	AC7025	PT15560
	TPU (main piece)	PVC w/metal clip spring	ABS
	ABS (backing)		Optional

<b>Environmental:</b>	Temp, Storage:	-40°F to +185°F	-40°C to +85°C
	Temp, Operating:	-40°F to +185°F	-40°C to +85°C
	Ingress Protection:	IP68	



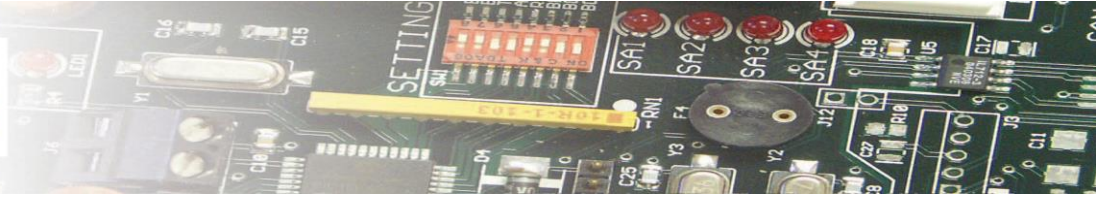

## Client List (Partial)

### USA Medical &

#### Pharmacies:

Abbot Labs  
 AmeriPharm  
 Amphenol  
 Anthem  
 Boston Scientific  
 Cardinal Health  
 CASI  
 CDS/Procare  
 Cigna Tel-Drug  
 CR Bard  
 CVS  
 Eckerd Drug  
 Edward's Life Science  
 Excellence  
 FamilyMeds.com  
 Humana  
 Intuitive Surgical  
 Kaiser Permanente  
 McKesson SI/Baker  
 Medtronic  
 Optum Rx  
 PacifiCare  
 Prescription Solutions  
 Providence Health Care  
 Rite Aid  
 Rx Direct  
 Smith's Medical  
 Synergy Medical  
 TCGRx  
 Tel-Drug  
 Veteran's Admin  
 Walgreens  
 WellPoint  
 Wyeth Labs

### USA Automotive:

Allen Bradley  
 ATS  
 Bendix  
 BMW  
 Caterpillar  
 Cummins Engines  
 Daimler AG  
 Decoma  
 Delphi  
 Detroit Diesel  
 Federal Mogul  
 Ford Motor Company  
 General Motors  
 Hirotec  
 Honda  
 Howmet  
 John Deere  
 Meridian Automotive  
 Michelin  
 Neaton Automotive  
 Polaris Industries

Toyota  
 Trident Automotive  
 Visteon  
 Volvo

### USA WIP:

Alcoa  
 Amana  
 AT&T  
 Avtron  
 BAE Automation  
 Boeing Corporation  
 BorgWarner  
 BW Rogers  
 Carlton-Bates  
 CEI Automation  
 Charbroil  
 Copeland  
 Cutler-Hammer  
 Eastman Kodak  
 EI DuPont  
 Electrolux  
 Eskay  
 Esselte  
 Estee Lauder  
 FlexLink Conveyors  
 Frigidaire  
 General Electric  
 Hyster Yates  
 Ingersoll Rand  
 Kim Automation  
 Knapp  
 Krauss-Maffei  
 Lear Jets  
 Marshall's  
 Maytag  
 Motorola  
 OshKosh B'Gosh  
 Osram Sylvania  
 Pepsi (Quaker)  
 Proctor & Gamble  
 Rockwell  
 SCI Sanmina  
 Sears  
 SI/Handling Systems  
 Square D Company  
 Siemens  
 Stanley Tools  
 Swisslog  
 Texas Instruments  
 Schick  
 Tempurpedic  
 TJ Maxx  
 TRW  
 Valeo Sylvania  
 WEPCO  
 Whirlpool  
 Wunderlich-Malec

### USA Discrete

#### Process Controls:

Ace Hardware  
 Cargill  
 Conagra  
 Exxon Mobil  
 Inland Steel  
 Nestle  
 Nippon Steel  
 POM Wonderful  
 U.S. Steel

#### USA Routing/ASRS:

AGV Products  
 Amerden  
 Anheuser-Busch  
 Bastian Solutions  
 Jervis Webb  
 JBT  
 Lemans  
 Los Angeles Times  
 Prilgrim's Pride  
 The Denver Post  
 The Boston Globe  
 Transbotics  
 Toyota AGV  
 U.S. Air Force

#### USA Entertainment

#### Customer Loyalty:

Bronx Zoo  
 CBS Television  
 Caesar's High Roller  
 Ferris Wheel  
 Electrosonic  
 Hard Rock Café  
 Heywood Engineering  
 Maltbie  
 NASCAR Hall of Fame  
 Northwest Airlines  
 Six Flags  
 Smithsonian Museum  
 Solomon Group  
 Strategic Systems  
 Technomedia  
 Vail Resorts  
 Walt Disney World  
 WWII Museum

#### USA Other:

Atmel/Temic  
 EFI Vutek  
 H.E. Butt Grocery  
 Hewlett Packard  
 Honeywell  
 Los Alamos Labs  
 Magic Chef  
 NASA  
 Nokia

Sandia National Labs  
 Timken  
 Tyco  
 U.S. Navy  
 Unilever  
 UPS

#### AVI Scale Operations:

American Scale  
 Apple Valley Scale  
 Avery Weigh-Tronix  
 Carlton Scale  
 Halliburton  
 Industrial Scale Systems  
 Meldrum Scale  
 Pacific Industrial Scale  
 Rice Lake Weighing  
 Sanstrom Scale  
 Standard Scale  
 Wingfield Scale

#### Asia:

IceGen (dist. India)  
 Electronic Corporation of India  
 FTRD (dist. China)  
 Tata Consultancy  
 Toyota (Japan)

#### Australia/Africa:

Alcoa World Alumina  
 BHP Billiton Iron Ore  
 Byrnecut Mining  
 CMA Systems  
 Dampier Salt  
 Fortescue Metals  
 Hamersley Iron  
 Logitech Consultants  
 Newcrest Telfer Gold Mine  
 Pacific Automation (dist, AUS)  
 Port Waratah  
 Queens Creek  
 Robe River Iron  
 Sinclair Knight Merz  
 ThyssenKrupp  
 Tomago Aluminum  
 Voest-Alpine

#### Canada:

AG Simpson Automotive  
 AMT Mach Tools (dist, Tor)  
 ArcelorMittal  
 Aurora Bar Code  
 City of Fort St. John  
 CraneSmart  
 Dofasco  
 Kellogg's Cereal  
 Keilhauer  
 LSZ PaperTech  
 Rotalec (distributor)

U.S. Steel

#### Central & South America:

Fenwal (Dominican Rep.)  
 General Electric (Mexico)  
 Hylsa (Mexico)  
 Logiseed (Dist Argentina)  
 MABE Leiser (Mexico)  
 SCI Sanmina (Mexico)  
 Retex (Peru)  
 RSI (Mexico)  
 TecWise (distributor, Brazil)  
 TRW (Mexico)

#### Europe:

BMW (UK)  
 FQ (distributor, Spain)  
 London Heathrow Airport  
 (Baggage)  
 Moncks & Crane (UK)  
 ProveIT  
 (distributor, UK)  
 SCI Sanmina (Hungary)  
 Securitas (Sweden)  
 Tempore (Austria)  
 TRW (UK & Germany)

#### USA Distributors:

Applied Automation (NY)  
 Applied Controls (PA, MD, DE)  
 Automation, Inc. (MN, ND, SD, IA, WI)  
 Buckeye Controls & Automation  
 (OH)  
 Burns Controls (TX)  
 C&E Advanced Tech (IN, OH, KY)  
 CodeSource (TX)  
 Cornerstone (TN, AL, GA, NC, SC, MS)  
 Gibson Eng. (MA, CT, ME, RI)  
 Industrial Controls (west MI)  
 Innovative Control Inc. (IL)  
 Lakeland Engineering (MN, WI, IA, ND, SD, MO, KS, NE)  
 Midwest Engineering (Ohio)  
 MSI Tech (CO, UT, AZ, NV, NM)  
 Power Motion (MO, KS, AK, OK, LA)  
 Power/mation (MN, IA, WI, IL)  
 Precise Motion (FL)  
 Prism (Eastern MI)  
 Proud Company (western PA)  
 PRI (NY, NJ)  
 RR Floody (IL, IA)  
 RZ Automation (IN)  
 Taylor Data (SC, NC, FL)  
 Valin Corporation (CA, AZ, UT, NV, WA, OR, ID)

