

# TERMINATOR

**Superior Quality  
& Exceptional  
Features**

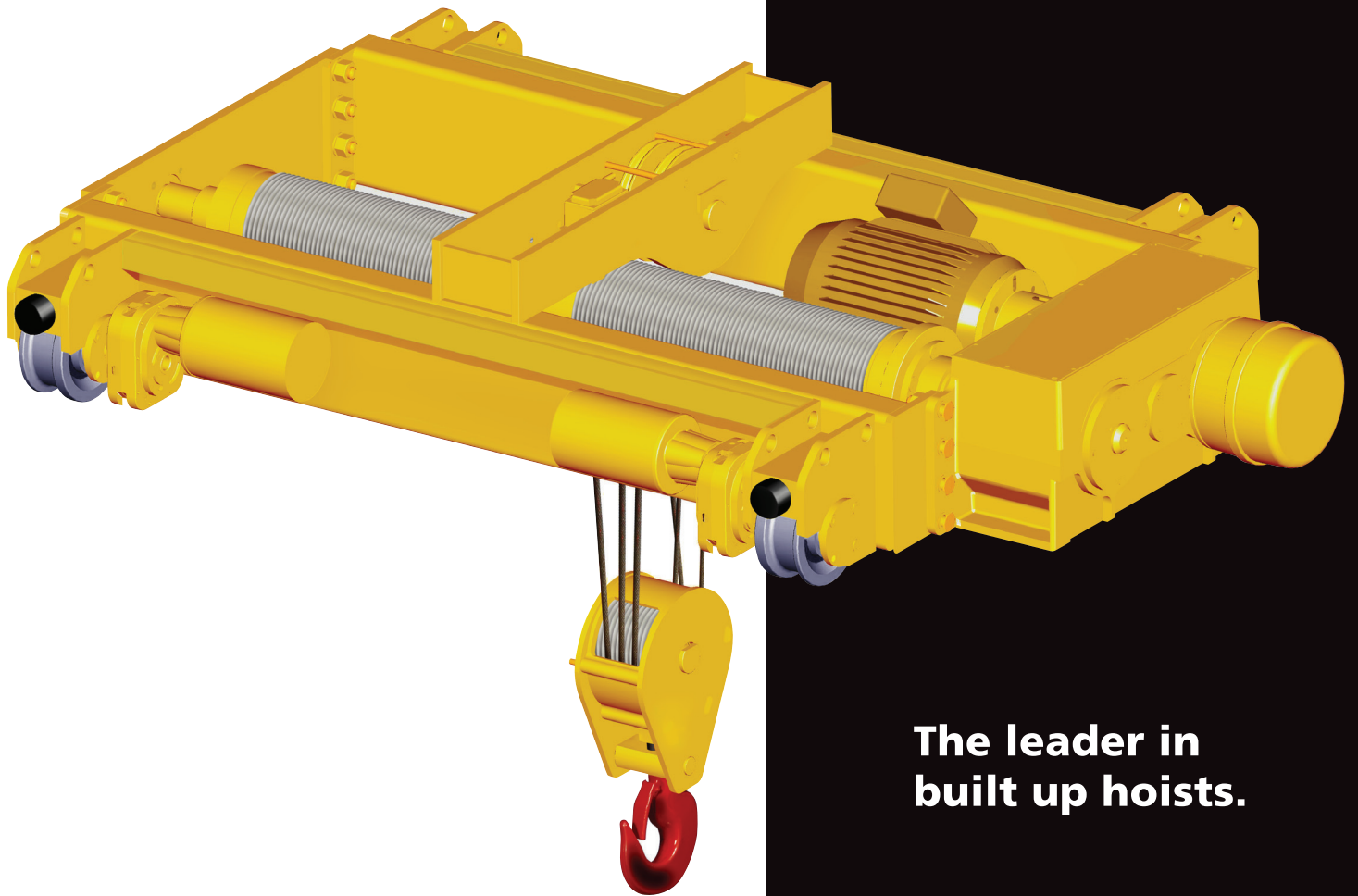

**The leader in  
built up hoists.**

**Now available in Monorail  
and Base Mount**

**Larger capacity, more lift and  
up to 60hp for faster speeds**



# Standard Features on all **TERMINATORS**

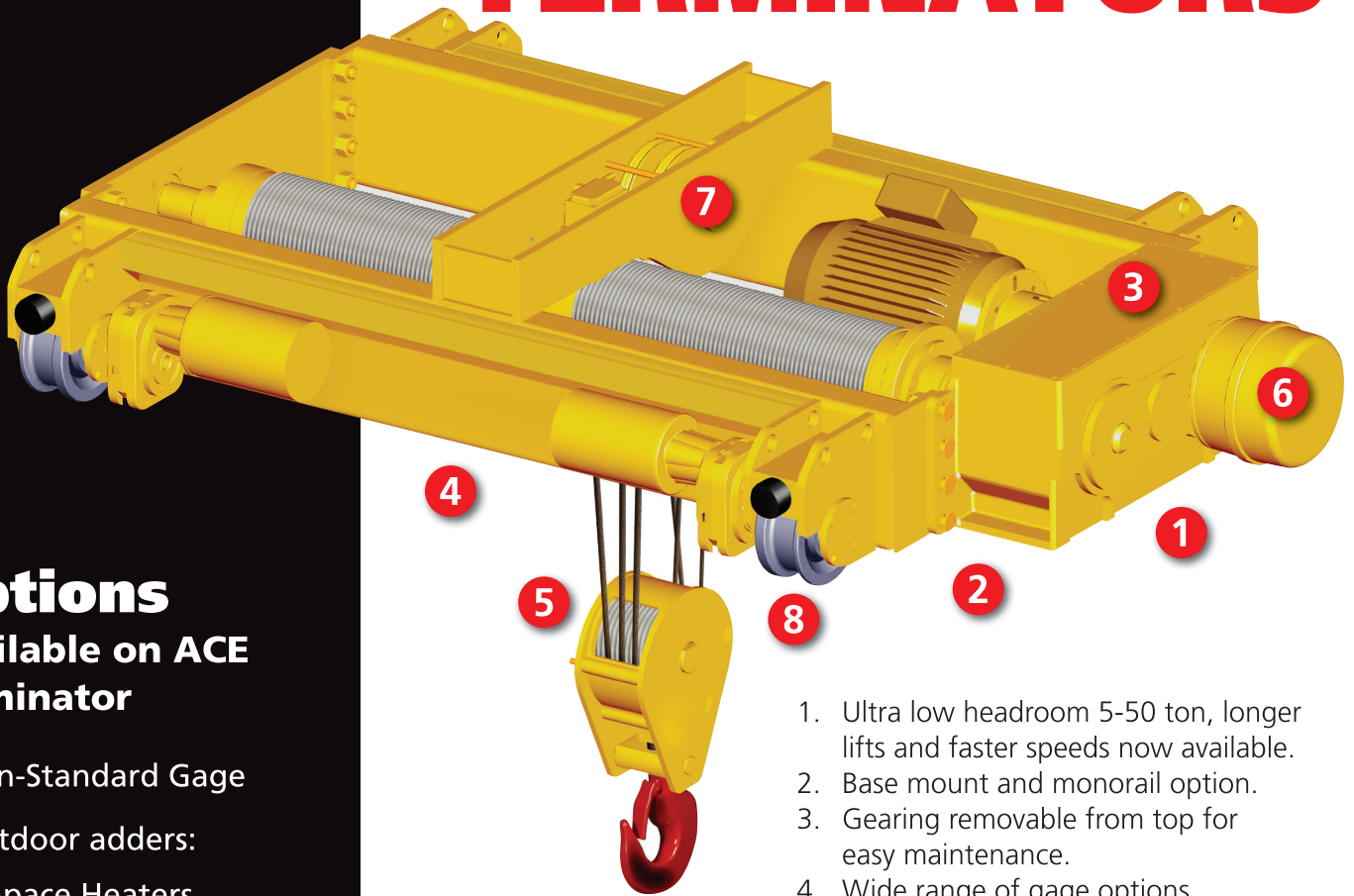

## Options Available on ACE Terminator

- Non-Standard Gage
- Outdoor adders:
  - Space Heaters
  - NEMA 4 or NEMA 4X
  - NEMA 4 Brake
- Epoxy Prime and Paint
- Commercial Blast
- Clustered Lubrication Points
- Trolley for 80# Rail
- Spooling Bar
- 120 fpm Trolley Speed
- Optional Voltages Available

1. Ultra low headroom 5-50 ton, longer lifts and faster speeds now available.
2. Base mount and monorail option.
3. Gearing removable from top for easy maintenance.
4. Wide range of gage options.
5. Double reeved / true vertical lift.

6. Midwest oil shear brake, industrial duty.
7. Rotary geared upper & lower control limit with added upper weighted limit.
8. Rotating axle trolley.

### Additional Features (not numbered):

- ACE VFD controls standard with inverter duty motors.
- Top Running Double Girder CMAA Class D for the most demanding applications.

Quick prices & drawings as well as crane kits available on our website:  
[AceWorldCompanies.com](http://AceWorldCompanies.com)



Overhead Cranes, Components  
and Engineered Systems

10200 Jacksboro Hwy. • Fort Worth, Texas 76135  
817.237.7700 • 800.431.4223 • 817.237.2777 Fax  
[www.AceWorldCompanies.com](http://www.AceWorldCompanies.com)

