

THE **ROLL-OUT SHEET RACK**



An operator retrieves thick plate out of a Crank-Out Sheet Rack Drawer with magnet lifter



A vacuum lifter retrieves an individual sheet out of a Crank-Out Sheet Rack Drawer

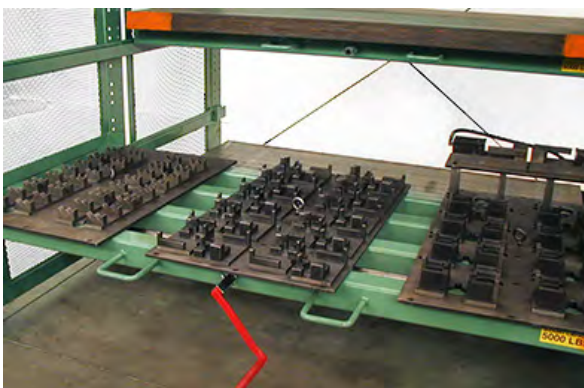

An open Crank-Out Sheet Rack Drawer storing tooling

Rugged Racks Designed for Storing Sheet Metal, Plate, & Other Heavy Product

INCREASED PRODUCTIVITY

Sheet Racks provide 100% accessibility to the material resulting in tremendous labor savings for your company. The roll out drawers extend completely for immediate access for placement and retrieval of material with a crane. Sheet Racks greatly compliment manufacturing machinery such as a laser and shear. They provide a simple yet inexpensive means to create an efficient and safe manufacturing cell.

IMPROVED SAFETY

Sheet Racks reduce unsafe conditions by eliminating piles of buried material. This not only results in a safer workplace but also reduces material damage that is particularly inherent with sheet and plate. All Sheet Rack models are accessed from the floor for convenience and safety.

BETTER HANDLING

Sheet Racks ease storage and handling operations allowing for more consistent handling of material located within the drawers. Models are available in either manual glide-out or crank-out designs for lighter or heavier loads, respectfully. Loading can be accomplished quickly and conveniently using a sheet lift, vacuum lifter, magnet, or even a forklift.

HIGHER DENSITY

Sheet Racks can increase operational capacity as much as four times as other storage methods. Sheet Rack Models are offered up to eight levels high and can be custom designed to fit your specific material handling needs. Sheet Racks are a practical and economic alternative to clumsy vertical upright racks or cost intensive cantilever storage systems.



A TOTAL CAPABILITY FOR STORING & HANDLING METAL



THE **ROLL-OUT** **SHEET RACK:** **STANDARD MODELS**

*The Sheet Rack
Improves Manufacturing
& Servicing Capacity*

- Roll-Out Sheet Racks allow the organization of inventory and work in progress items by size, type, gauge, material type, etc.
- One operator using an overhead crane can load or retrieve material instantly.
- Roll-Out Sheet Racks complement laser cutters, shears, press brakes, and other production machinery.
- Standard Models have between 4 and 8 roll-out storage levels with 5,000 lbs. capacity per drawer.
- The Drawers are spaced 4", 6", 8", 10", or 12" apart with an overall rack height of 73", 79", or 81".

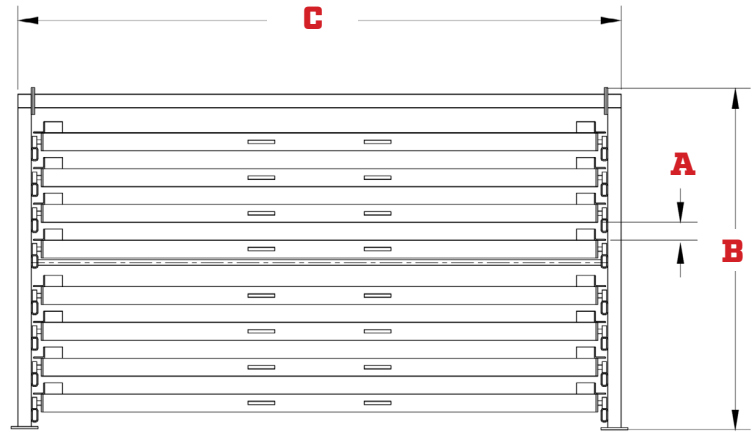

Front view of a 8 High Roll-Out Sheet Rack

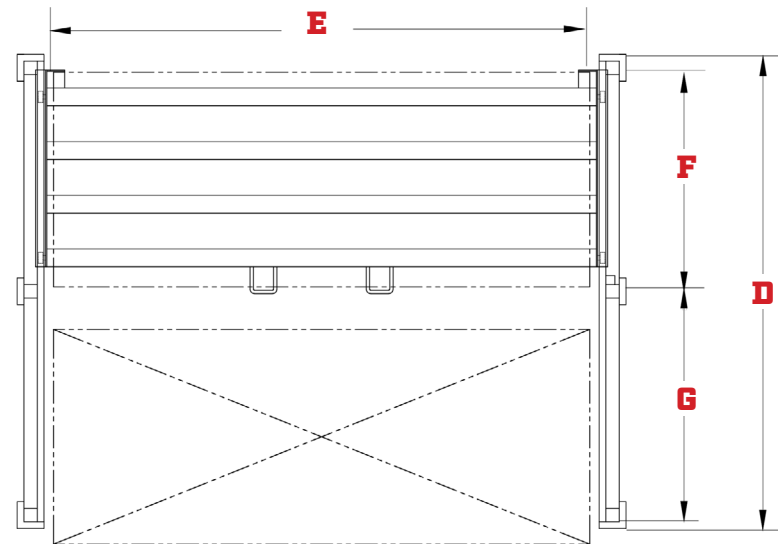

Top view of a Roll-Out Sheet Rack

Standard 5K Drawer Capacity Model Specifications

| Model | 48 X 96R | | | | | 48 X 120R | | | | | 60 X 120R | | | | | 60 X 144R | | | | | 72 X 144R | | | | |
|------------------------|----------|-----|-----|-----|-----|-----------|-----|-----|-----|-----|-----------|-----|-----|-----|-----|-----------|-----|-----|-----|-----|-----------|-----|-----|-----|-----|
| Drawer Capacity | 5,000# | | | | | 5,000# | | | | | 5,000# | | | | | 5,000# | | | | | 5,000# | | | | |
| Number of Drawers | 4 | 5 | 6 | 7 | 8 | 4 | 5 | 6 | 7 | 8 | 4 | 5 | 6 | 7 | 8 | 4 | 5 | 6 | 7 | 8 | 4 | 5 | 6 | 7 | 8 |
| Drawer Height | 12" | 10" | 8" | 6" | 4" | 12" | 10" | 8" | 6" | 4" | 12" | 10" | 8" | 6" | 4" | 12" | 10" | 8" | 6" | 4" | 12" | 10" | 8" | 6" | 4" |
| Rack Height (B) | 73" | 79" | 81" | 79" | 73" | 73" | 79" | 81" | 79" | 73" | 73" | 79" | 81" | 79" | 73" | 73" | 79" | 81" | 79" | 73" | 73" | 79" | 81" | 79" | 73" |
| Rack Length (C) | 111" | | | | | 135" | | | | | 135" | | | | | 159" | | | | | 159" | | | | |
| Rack Width (D) | 103" | | | | | 103" | | | | | 127" | | | | | 127" | | | | | 151" | | | | |
| Drawer Length (E) | 98" | | | | | 122" | | | | | 122" | | | | | 146" | | | | | 146" | | | | |
| Drawer Width (F) | 50" | | | | | 50" | | | | | 62" | | | | | 62" | | | | | 74" | | | | |
| Roll-Out Extension (G) | 56" | | | | | 56" | | | | | 68" | | | | | 68" | | | | | 80" | | | | |

THE **ROLL-OUT SHEET RACK:** **CRANK-OUT MODELS**

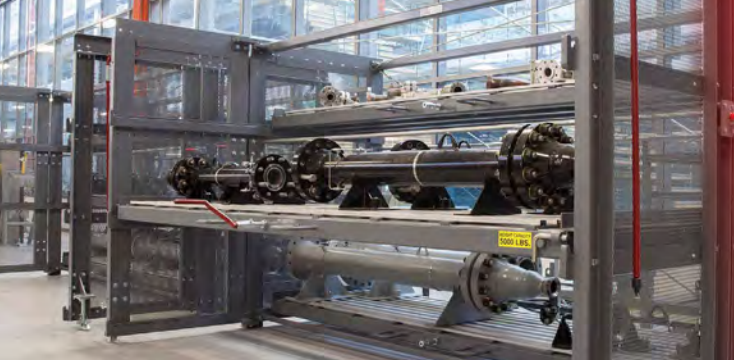

The Crank-Out Sheet Rack Handles Heavy Loads with Ease

A Crank-Out option is available for all 5,000# Drawer Capacity Sheet Rack models. The ergonomic drives provide smooth and easy movement. The drive reduces the effort to 20% of a glide-out drawer.

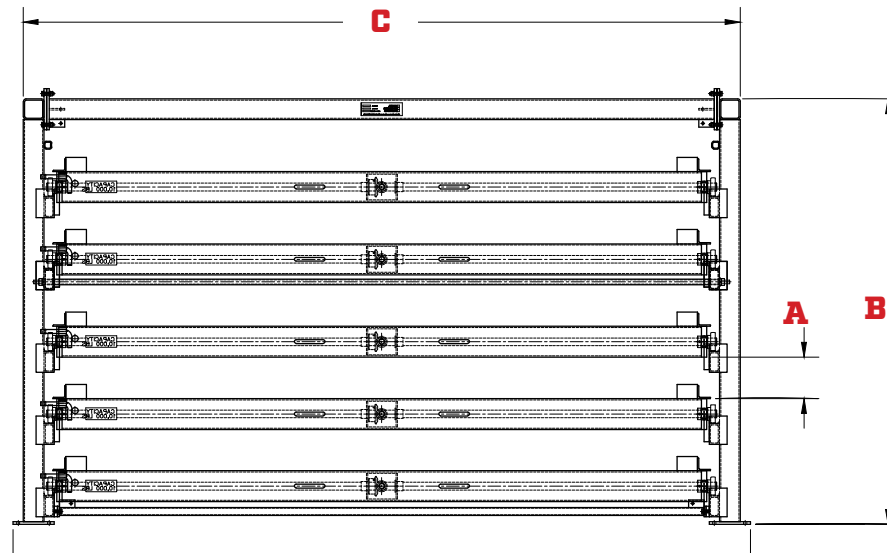

Front view of a 5 High Crank-Out Sheet Rack

10,000# CRANK-OUT MODELS

The 10,000# weight capacity Crank-Out Sheet Rack Models are designed with 4, 5, or 6 drawers, for storing 5' x 10' up to 6' x 12' material.

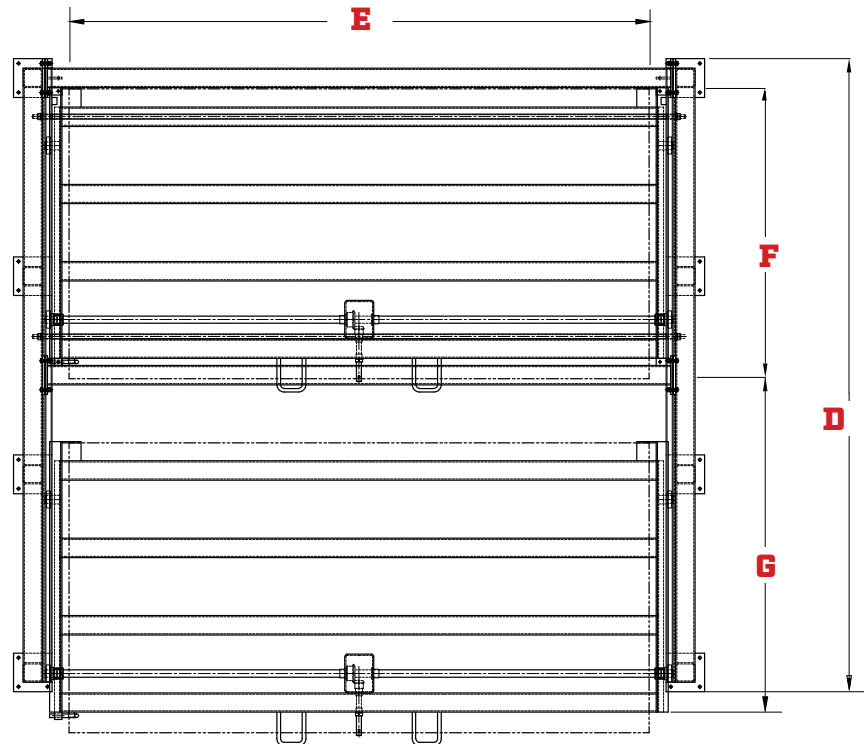

Top view of a Crank-Out Sheet Rack

10K Drawer Capacity Model Specifications

| Model | 60 X 120R | | | 72 X 144R | | |
|------------------------|-----------|----|----|-----------|----|----|
| | 4 | 5 | 6 | 4 | 5 | 6 |
| Drawer Capacity | 10,000# | | | 10,000# | | |
| Number of Drawers | 4 | 5 | 6 | 4 | 5 | 6 |
| Drawer Height | 12" | 8" | 6" | 12" | 8" | 6" |
| Rack Height (B) | 83" | | | 83" | | |
| Rack Length (C) | 139" | | | 163" | | |
| Rack Width (D) | 127" | | | 151" | | |
| Drawer Length (E) | 122" | | | 146" | | |
| Drawer Width (F) | 62" | | | 72" | | |
| Roll-Out Extension (G) | 73" | | | 85" | | |

THE **ROLL-OUT SHEET RACK:**

CUSTOM MODELS

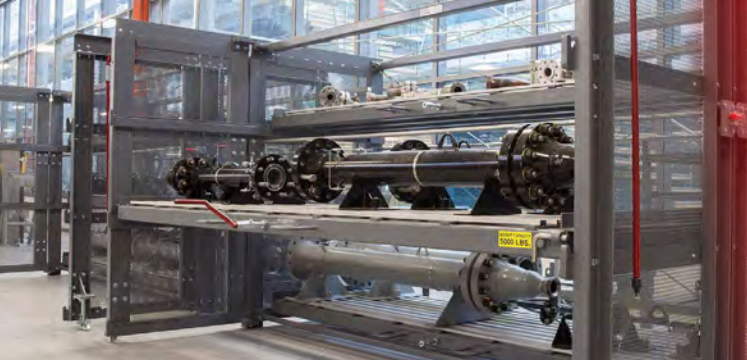

The Sheet Rack Compliments Processing Applications & is Designed to User Specifications



A 3H Crank-Out Sheet Rack with Hinged Side-Frames (above)

THE HINGED SIDE-FRAME MODEL

Side-Frames are hinged and fold in when the Rack is not in use. This frees up the roll-out space making the rack further compact and provide aisle space.

THE DOUBLE-SIDED MODEL

Drawers glide out to full-extension on either side of the Rack. This model is best installed either centered between two processing machines or two bays of a building.

REAR-LOADING MODEL

Rack structure is reinforced for handling material with a forklift. This allows access on both sides of the Rack. Pallets of material can be loaded via forklift from the back and individual sheets may be retrieved via overhead crane from the front.

Drawers may be equipped with **Forklift Risers**; 2" square tubes to allow fork access.

MOTORIZED DRAWER

Drawers power in and out smoothly and quickly to increase operator safety. Ideal for 10,000# Drawer Capacity Racks.

TOP LEVEL SUPPORT

Provides an additional storage space on the top of the Rack.

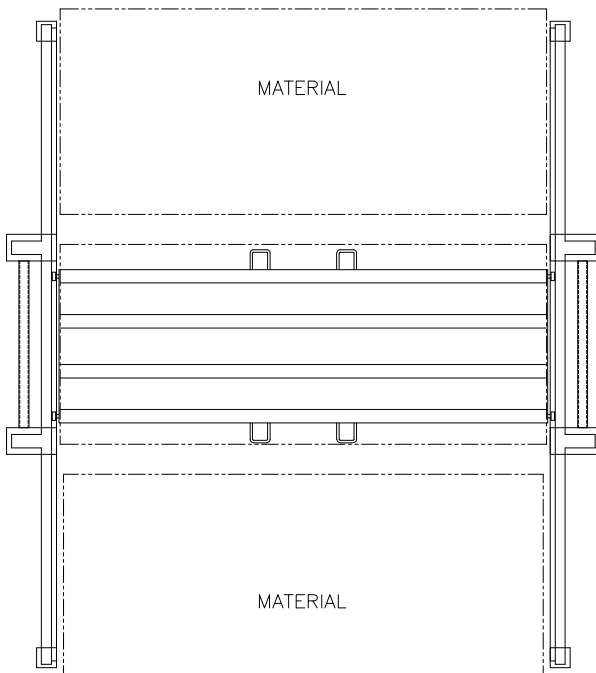

Top view of a Double Sided Sheet Rack

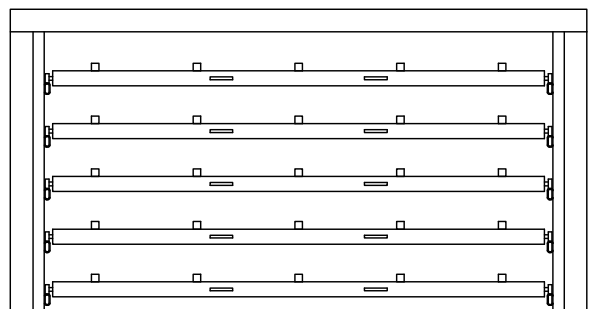

Front view of a 5H Sheet Rack equipped with Forklift Risers