

EZ Loader[®]

Automatic Pallet Positioner

Working Harder To
Make Your Life Easier

EZ Loader[®]

Automatic Pallet Positioner

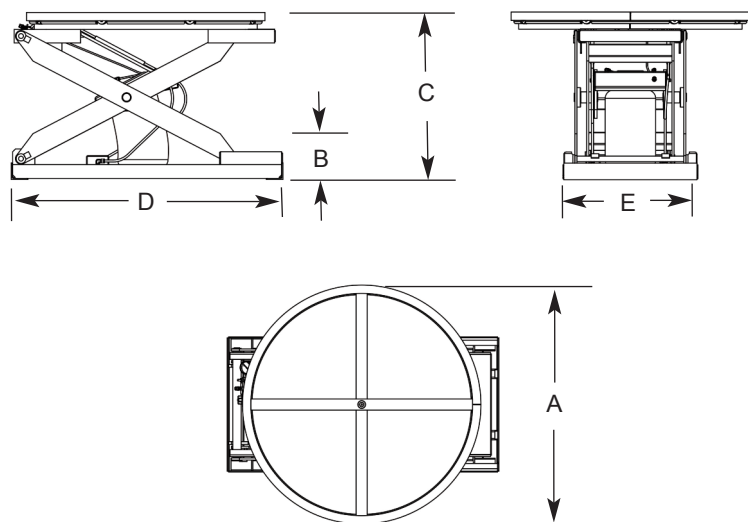

EZ Loader Specifications

- (A) Rotator Ring Diameter = 43.0 inches (1092 mm)
- (B) Lowered Height = 10.5 inches (267 mm)
- (C) Raised Height = 30.5 inches (775 mm)
- (D) Base Frame Length = 49.0 inches (1245 mm)
- (E) Base Frame Width = 24.3 inches (617 mm)
- Minimum Self Leveling Capacity = 250 lbs (113 kgs)
- Maximum Self Leveling Capacity = 3500 lbs (1588 kgs)
- Maximum Load Capacity = 4000 lbs (1814 kgs)
- Travel = 20.0 inches (508 mm)
- Air Pressure Capacity Adjustment = Infinite
(10 – 60 psi / 0.7 – 4.1 bar)
- On-board Capacity Adjustment = 3 position knob
(light – medium – heavy)

The EZ Adjust Knob allows adjustment of the collapsed capacity without having to change the air pressure!



EZ Loader Performance Chart

UnLoaded Air Pressure Setting (psi)	Total Pallet Weight (lbs)		
	Light Weight Position	Medium Weight Position	Heavy Weight Position
12	250 - 450	725 - 800	900 - 1000
15	550 - 600	800 - 900	1100 - 1200
20	700 - 750	1000 - 1100	1350 - 1450
25	850 - 925	1200 - 1300	1550 - 1700
30	1000 - 1100	1375 - 1525	1775 - 1950
35	1150 - 1250	1600 - 1750	2000 - 2200
40	1300 - 1450	1825 - 2000	2300 - 2500
45	1475 - 1625	2000 - 2200	2550 - 2750
50	1625 - 1775	2200 - 2400	2800 - 3000
55	1775 - 1950	2375 - 2575	3050 - 3275
60	1950 - 2100	2600 - 2825	3300 - 4000

Based on a standard EZ Loader with rotator ring and no options. Addition of solid tops, etc. will vary the PSI required.

The Most Advanced Pallet Positioner Available

Now Adjustable Without Changing The Air Pressure!

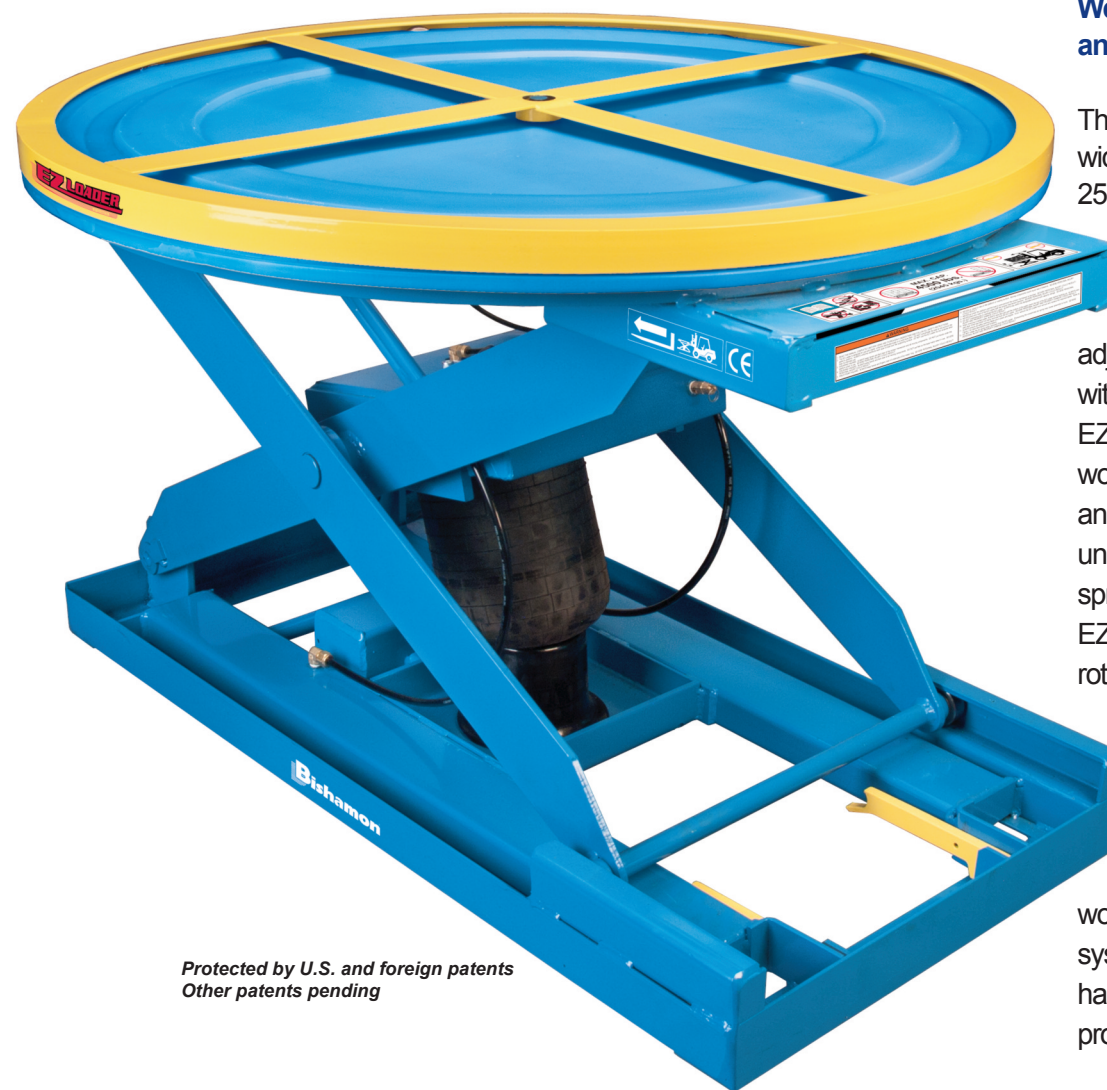

We took the unparalleled EZ Loader and made it even more user friendly!

The new EZ Loader can now handle a wide range of weight capacities from 250 lbs up to 4,000 lbs.

To make it even better, we added the EZ Adjust knob - a three position knob that allows

adjustment of the collapsed capacity without changing the air pressure! EZ Loaders are designed to eliminate worker bending by automatically raising and lowering pallets during loading or unloading without the use of mechanical springs, motors or hydraulics. EZ Loaders also allow easy pallet rotation for near-side loading so the worker does not have to reach or strain. As the load weight changes, the EZ Loader automatically adjusts, keeping the top of the load at a convenient working height. The patented pneumatic system found only on the EZ Loader has proven to be the choice of industry professionals worldwide.

Protected by U.S. and foreign patents
Other patents pending

DISTRIBUTED BY:



5651 East Francis Street
Ontario, California 91761-3601
PH: 800-358-8833 US & Canada
909-390-0055 Outside US/CN
Fax: 800-700-0492

www.bishamon.com



Shown here are the pressure gauge, the air fill & bleed valves, and the EZ Adjust knob that provides up to 1200 lbs of capacity adjustment with the simple turn of a knob

Warranty - Bishamon Industries Corp. ("Bishamon") warrants its products to be free from defects in material and workmanship for a period of one (1) year from the date of initial shipment. This warranty shall not apply to any misuse, mishandling, accident, shipping, alteration, or unauthorized repair of any Bishamon product or part. For complete details of warranty, please contact Bishamon at 800-358-8833.

The Perfect Ergonomic Tool

Made In California USA!



“Attention to detail for worker safety is paramount”

Standard Features:

- Self-leveling design automatically keeps the top of the load at a convenient working height to help eliminate bending and improve productivity
- Integral rotator ring helps eliminate reaching and stretching
- Captive air operation eliminates cumbersome mechanical springs and gives more controlled (dampened) movement of the platform
- A three position EZ Adjust knob allows adjustment of the collapsed capacity without changing air pressure
- Secured ball bearing center pivot of the 43" diameter rotator ring provides smooth, even rotation
- Pressure relief valve prevents excess pressure build-up
- Surfaces are phosphatized and powder coated with a high quality polyester for a lasting, durable finish
- Rollers are entrapped in the base frame and platform for added stability
- A full coverage finger guard eliminates pinch points between the rotator underside of the rotator ring and the bearings
- Integral maintenance blocks
- EZ Loaders arrive at your facility fully assembled - just add air!
- Easily transported with a fork truck or via optional portability packages
- The EZ Loader is CE marked under the Machinery Directive (2006/42/EC)

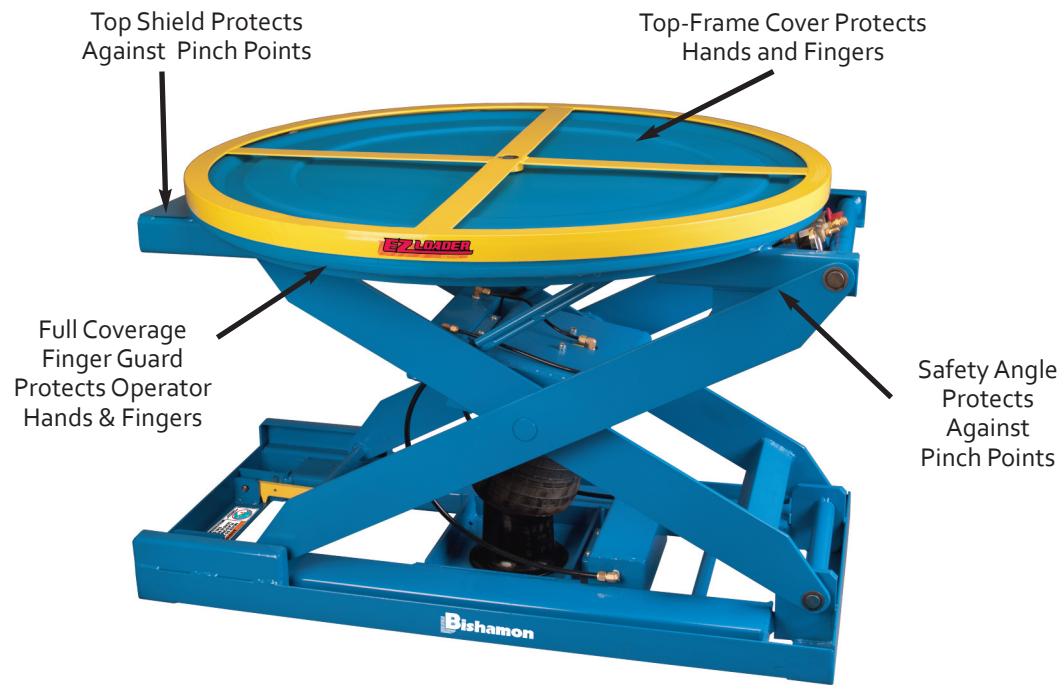

The Bishamon EZ-Loader Complies With All Machinery Directive 2006/42/EC Safety Requirements - And Is CE Approved!



Patented Self-Contained Pneumatic System Offers Unsurpassed Performance



EZ Adjust Knob Provides Up To 1200 lbs Of Capacity Adjustment With the Turn of a Knob

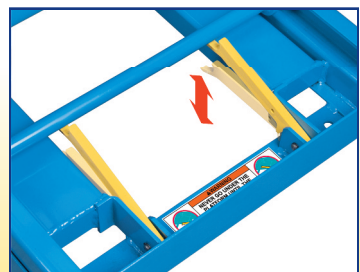

Hinged Maintenance Bars For Added Safety

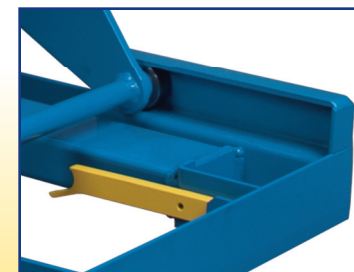

Rollers Are Entrapped In The Base Frame And Platform For Added Stability

EZ Loader Models

EZ LOADER	Standard powder coated finish
EZ LOADER-E	FDA compliant powder coated finish with stainless solid round top
EZ LOADER-SS	Grade 304 stainless steel with electro-polished finish
EZ LOADER-2848	Fixed non-rotating platform 28" x 48"
EZ LOADER-3648	Fixed non-rotating platform 36" x 48"



EZ Loader



EZ Loader-2848

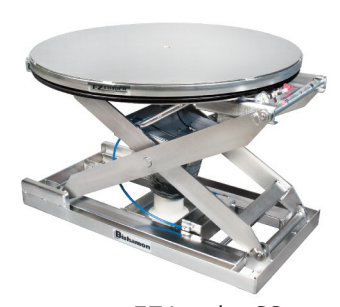

EZ Loader-SS

EZ Loader Accessories

EZ-BRK	Rotator ring brake to prevent rotation
EZ-ABS	Accordion bellows skirting with frame
EZ-SLP	Semi-live portability for moving unloaded lift (2 wheels & dolly handle)
EZ-CART	Cart portability with 2 swivel and 2 rigid wheels (add 7" to lowered height)
EZ-SRT	Solid 43" diameter round top
EZ-4444	Oversize rectangular rotating platform (44"x44")
EZ-4448	Oversize rectangular rotating platform (44"x48")
EZ-4848	Oversize rectangular rotating platform (48"x48")
EZ-SRT-DNT	Solid 43" diameter round top with 90 degree detents
EZ-4444-DNT	Oversize rectangular rotating platform (44"x44") with 90 degree detents
EZ-4448-DNT	Oversize rectangular rotating platform (44"x48") with 90 degree detents
EZ-4848-DNT	Oversize rectangular rotating platform (48"x48") with 90 degree detents
EZ-TT	Floor Mounted 4,500# capacity, 43 in. dia. rotating turntable - 3.18 in. high



Solid Rotating Top



OS Rotating Platform



Cart Portability



Semi Live Portability

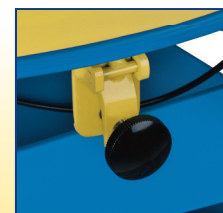

Rotator Ring Brake



Bellows Skirting

No Need For Fork Pockets That Pose A Trip Hazard!



Easily Transport The EZ Loader With Your Fork Truck!