

1

Tabletop made of tear metal

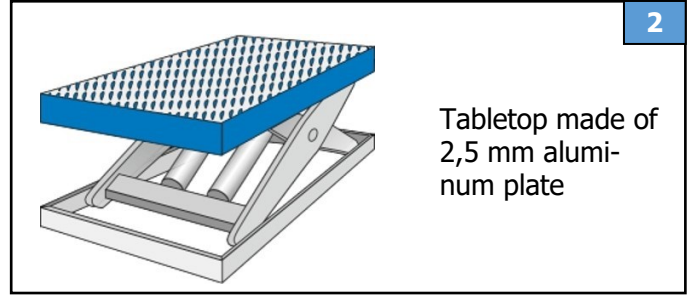

2

Tabletop made of 2,5 mm aluminum plate

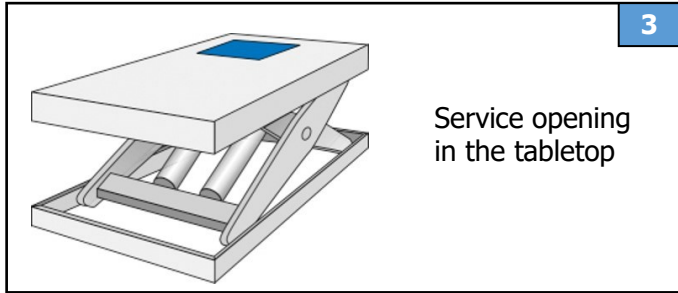

3

Service opening in the tabletop

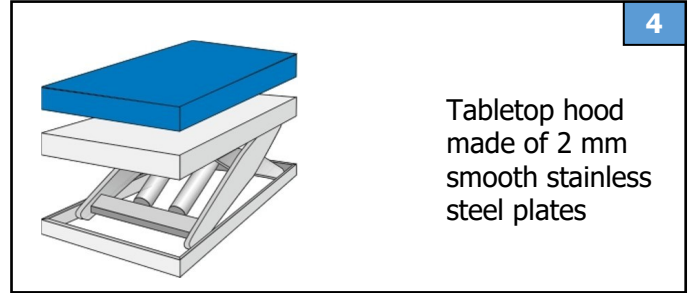

4

Tabletop hood made of 2 mm smooth stainless steel plates

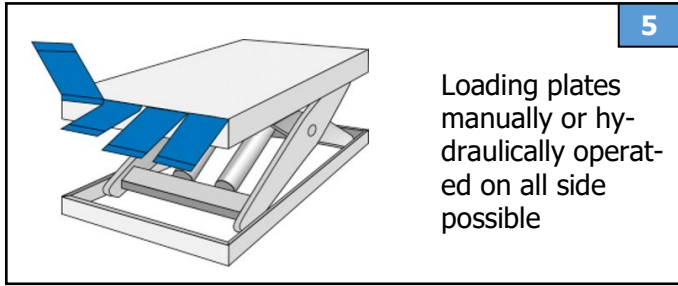

5

Loading plates manually or hydraulically operated on all side possible

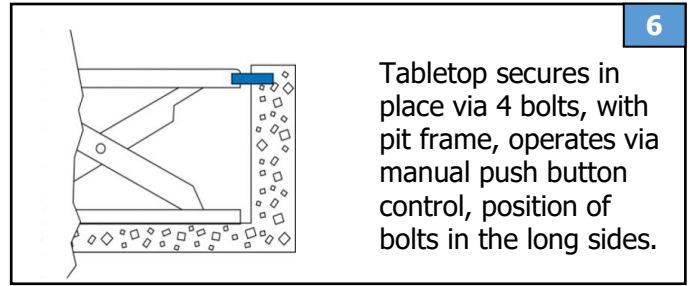

6

Tabletop secures in place via 4 bolts, with pit frame, operates via manual push button control, position of bolts in the long sides.

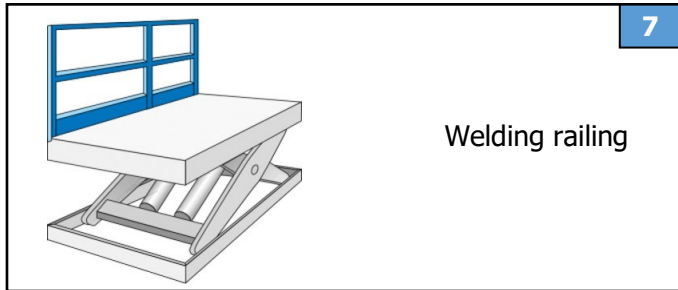

7

Welding railing

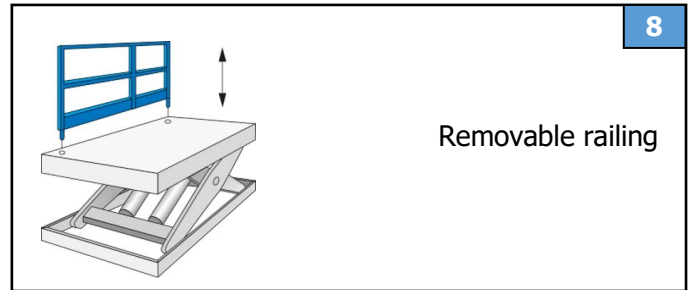

8

Removable railing

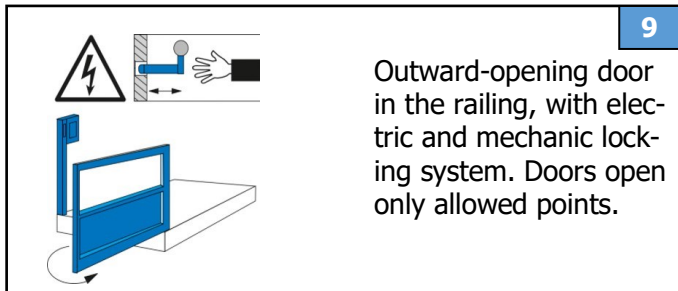

9

Outward-opening door in the railing, with electric and mechanic locking system. Doors open only allowed points.

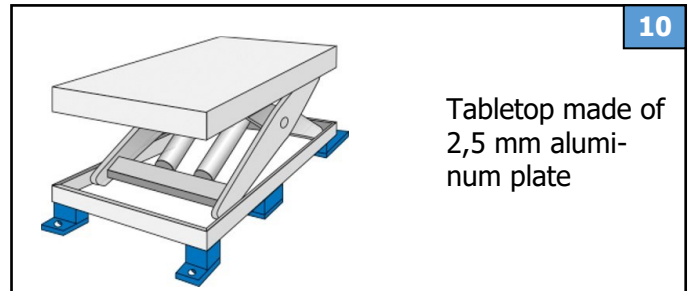

10

Tabletop made of 2,5 mm aluminum plate

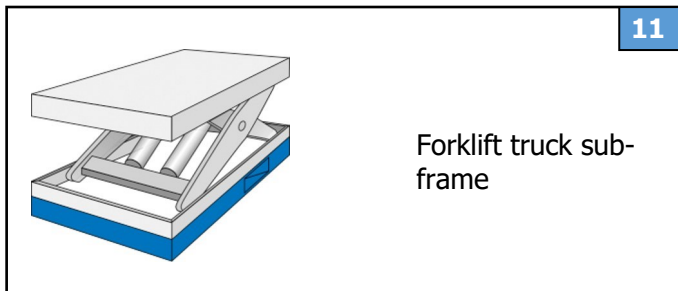

11

Forklift truck sub-frame

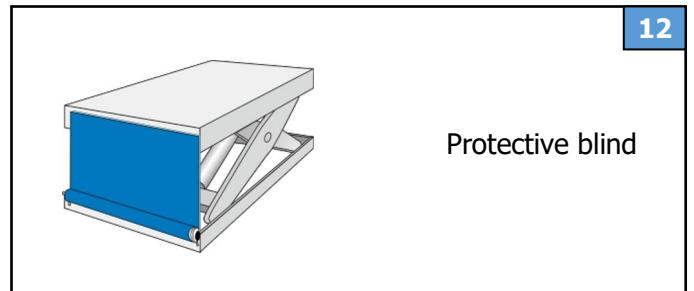

12

Protective blind

13

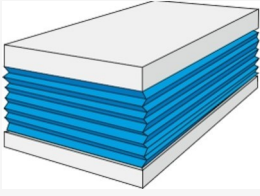

Protective bellow

14

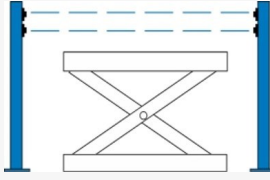

Photocell control system

15



Lifting table with rolling undercarriage

16

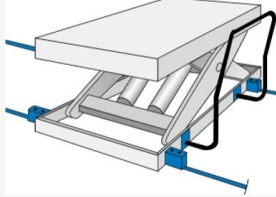

Lift table with rail bound traveling system

17

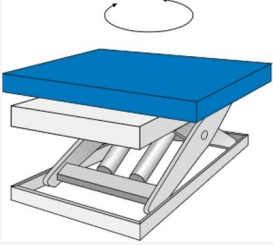

Lift table with rotating platform

18

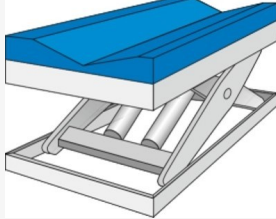

Lift table with prism surface

19



Lifting table with roller bearing platform

20

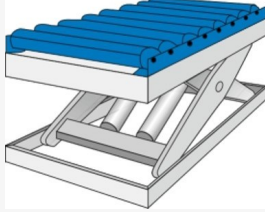

Lift table with roller conveyor

21

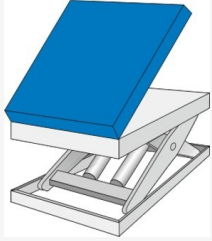

Lift table with tilting platform

ONDLIFT Mak. San. Tic. Ltd. Şti

Factory: Organize Sanayi Bolgesi 2004 Cad. No: 4
Turgutlu/Manisa/TURKEY

Showroom: İmes San. Sit. C.302 Sk. No:13
Y.Dudullu/Umraniye/Istanbul/TURKEY

Tel: 0090 236 332 5050

ondlift@ondlift.com

Product specifications are subject to change without any notice or obligation. The photographs and/or drawing in this documents are for illustrative purpose only. All productions of OndLift, manufacturing for CE standards.

Turkey
Discover the potential

Onder Lift Celik



43rd Years Anniversary

Your warehous partner

Onder Group Company